

Bullmerwerk G. O. Stumpf GmbH - Spezialmaschinenfabrik - 7421 Mehrstetten - Telefon (0 71 81) 1 83-0 - Telex 7 19 323 - Telefax (0 73 81) 7 23

**bullmer
werk**

Stofflegeautomat CNC-Super-Robot 30

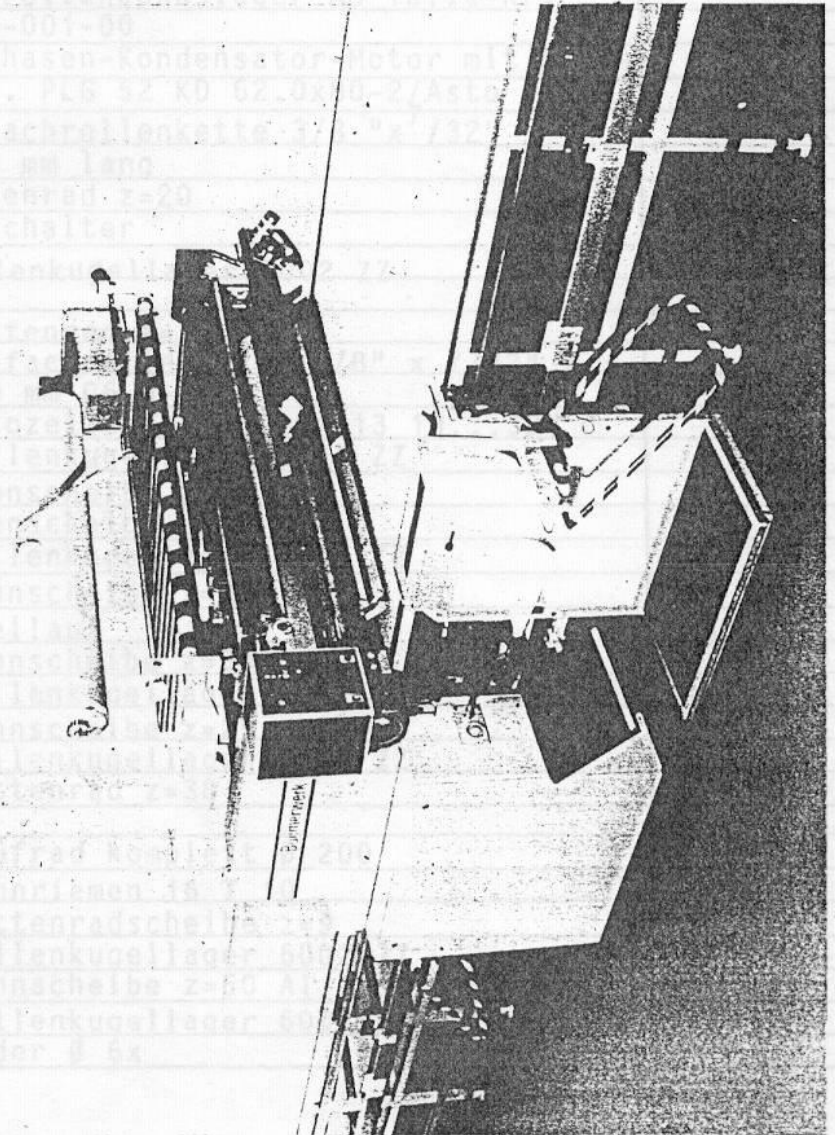

Ersatzteilliste

9	80017	Kettenspanner
10	80016	Kettenspanner
11	80077	Drehflansch
12	80079	Kettenspanner
13	12940	Konus Spannelement TLK 250
14	12942	Radlager abgedichtet m. Ring
15	80037	Kettenspanner
16	5386	Wälzlager 6001 2 7
17	12620	Polster für 377x510x76, +223
18	80130	Wälzlager
19	5387	Wälzlager 609
20	12938	Verbindungsstück mit Feder für zwei
21		Wälzlager 069-2
22		Wälzlager 001-06
23		Wälzlager Kondensator Motor m
24		Wälzlager 52 KD 02.0x 22/24
25		Wälzlager
26		Wälzlager
27		Wälzlager
28		Wälzlager
29		Wälzlager
30		Wälzlager
31		Wälzlager
32		Wälzlager
33		Wälzlager
34		Wälzlager
35		Wälzlager
36		Wälzlager
37		Wälzlager
38		Wälzlager
39		Wälzlager
40		Wälzlager
41		Wälzlager
42		Wälzlager
43		Wälzlager
44		Wälzlager
45		Wälzlager
46		Wälzlager
47		Wälzlager
48		Wälzlager
49		Wälzlager
50		Wälzlager

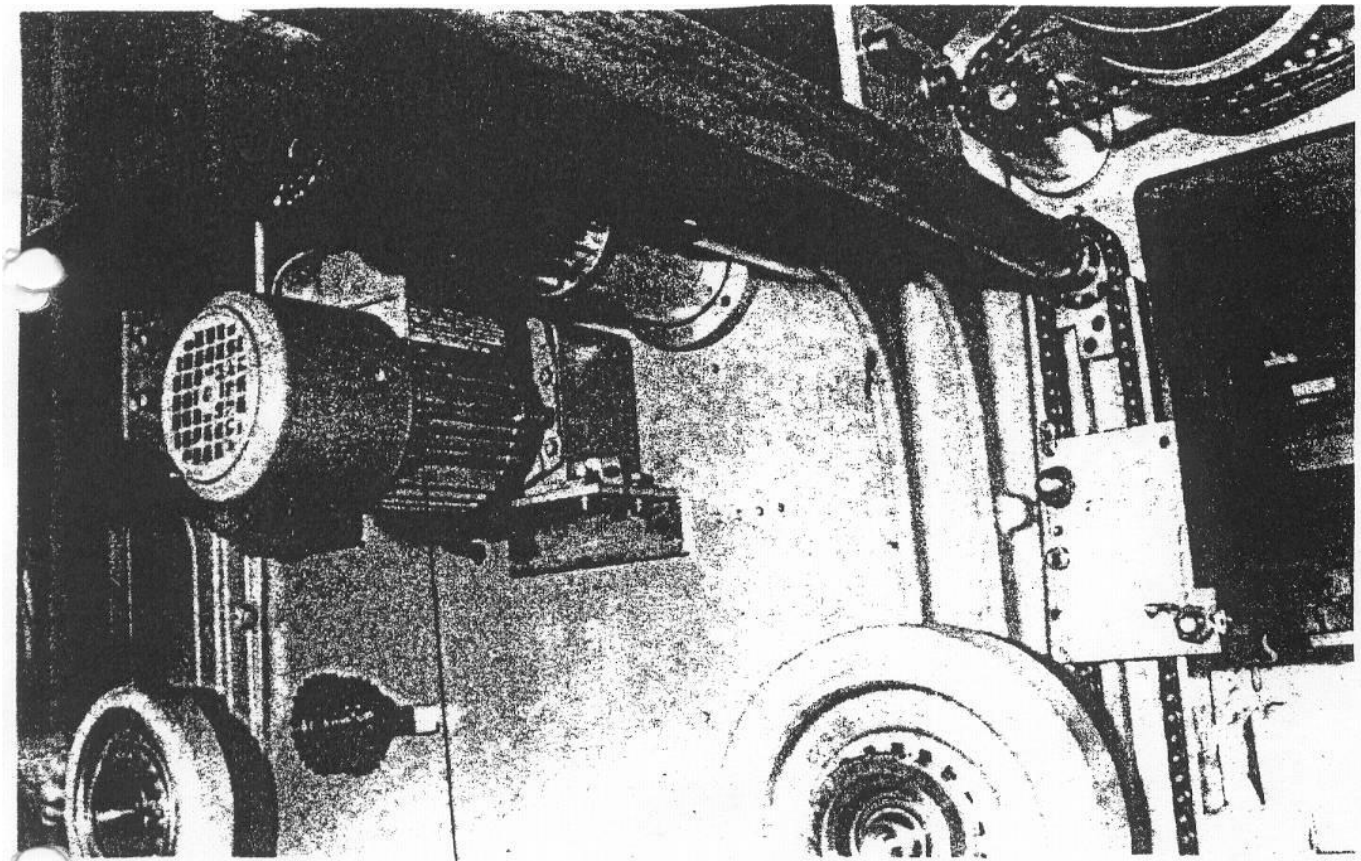

12 318 Mini-Getriebe-Bremsmotor
80 072 Kettenrad

80576 Kettenrad

16059 Kettenrad

80720 Kettenrad
gegenüberliegend

19825 Zugfeder

7384 Kurvenrolle

11806 Rollenkette

18728 Kettenrad

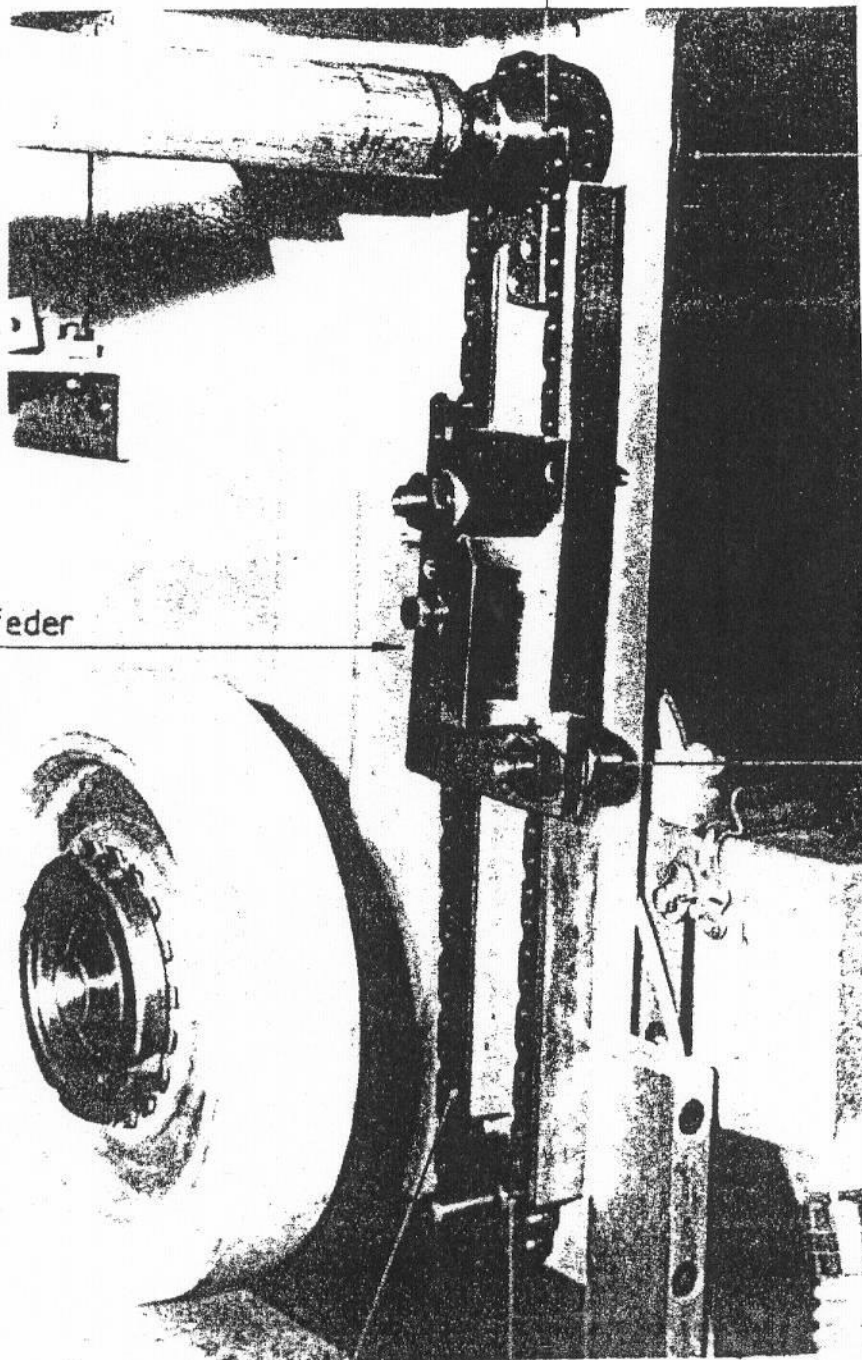

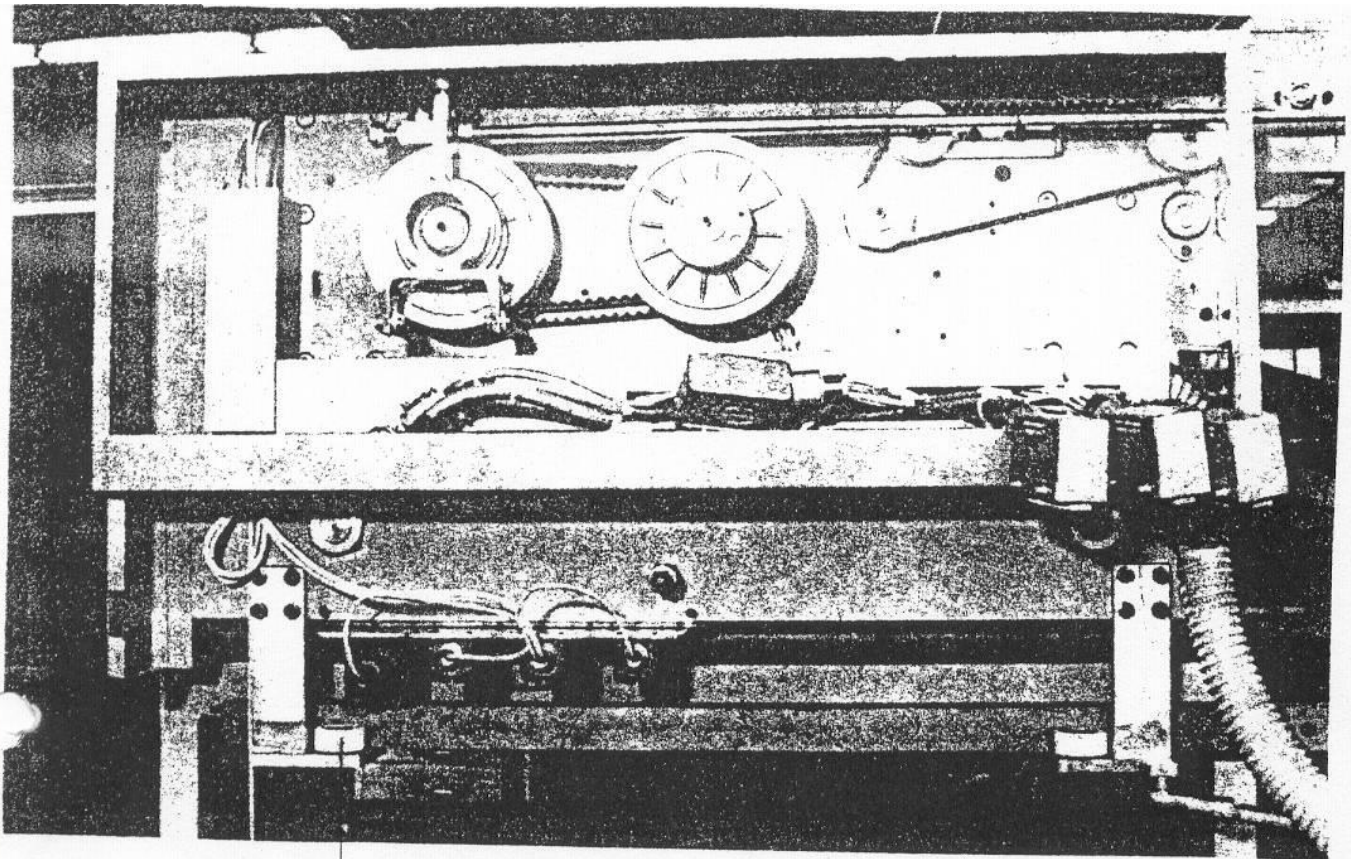

80 372 Laufrolle
7973 Kurvenrolle

19966 Laufrad
80 055 Kettenrad
7062 Rillenkugellager 6205 ZZ

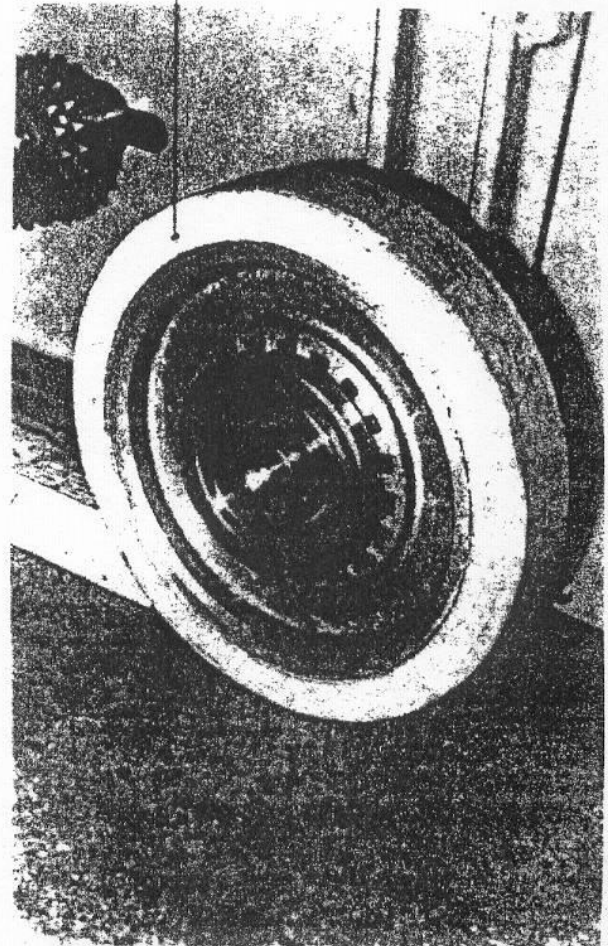
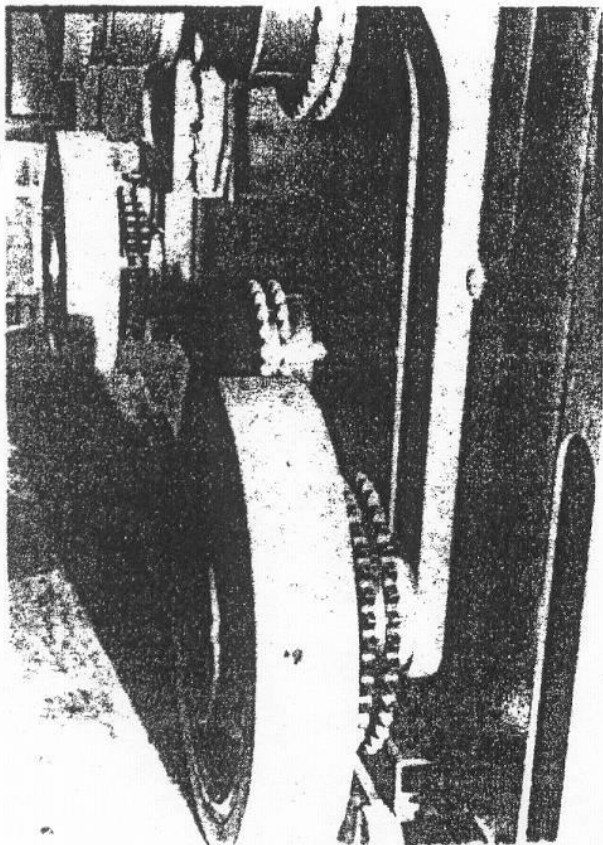

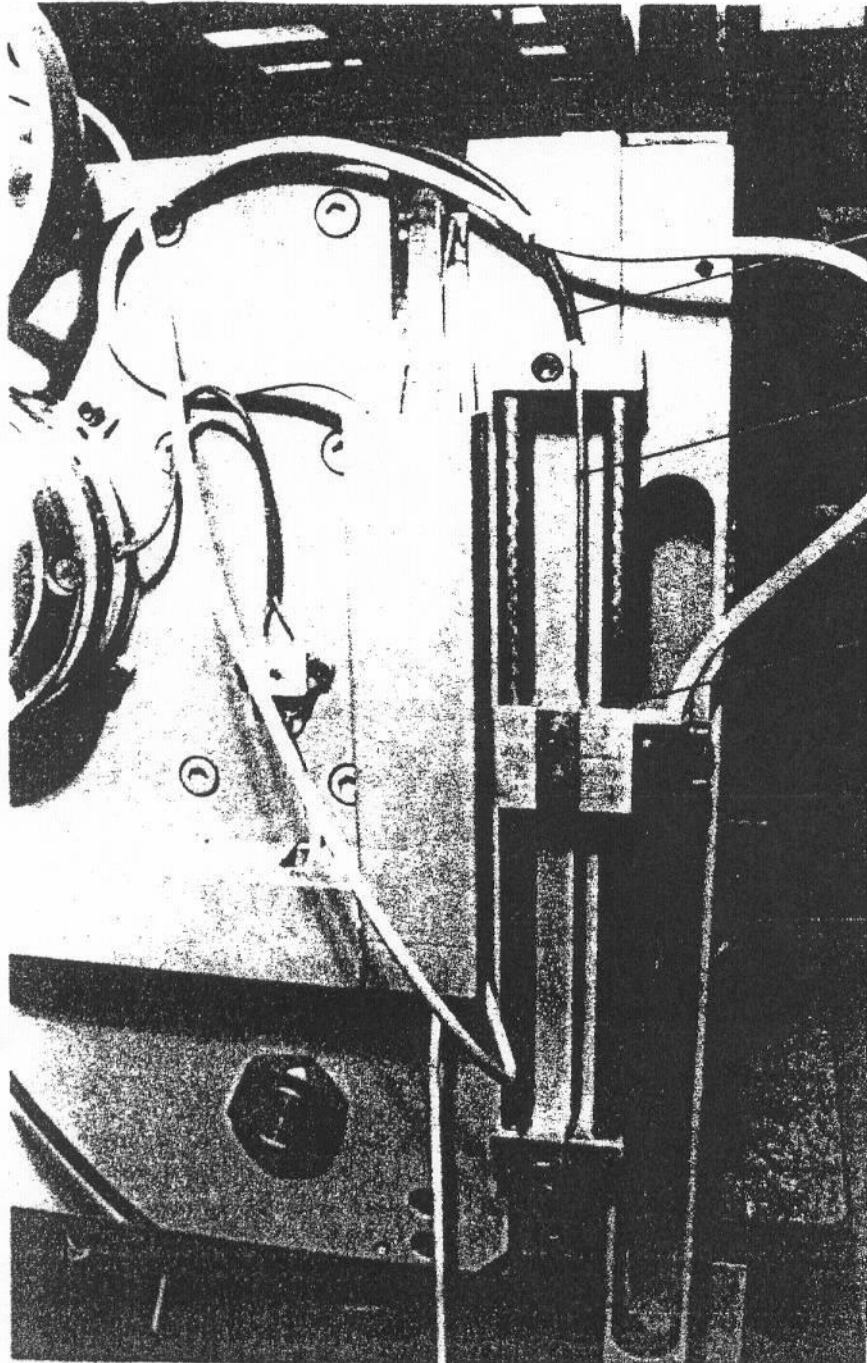

12 591

12 592

12 590 Drahtseil

12 819 DU-Buchse

11 985 Fotozelle

12 353 Reflektoren
auf Gegenseite

4823 Meßrad

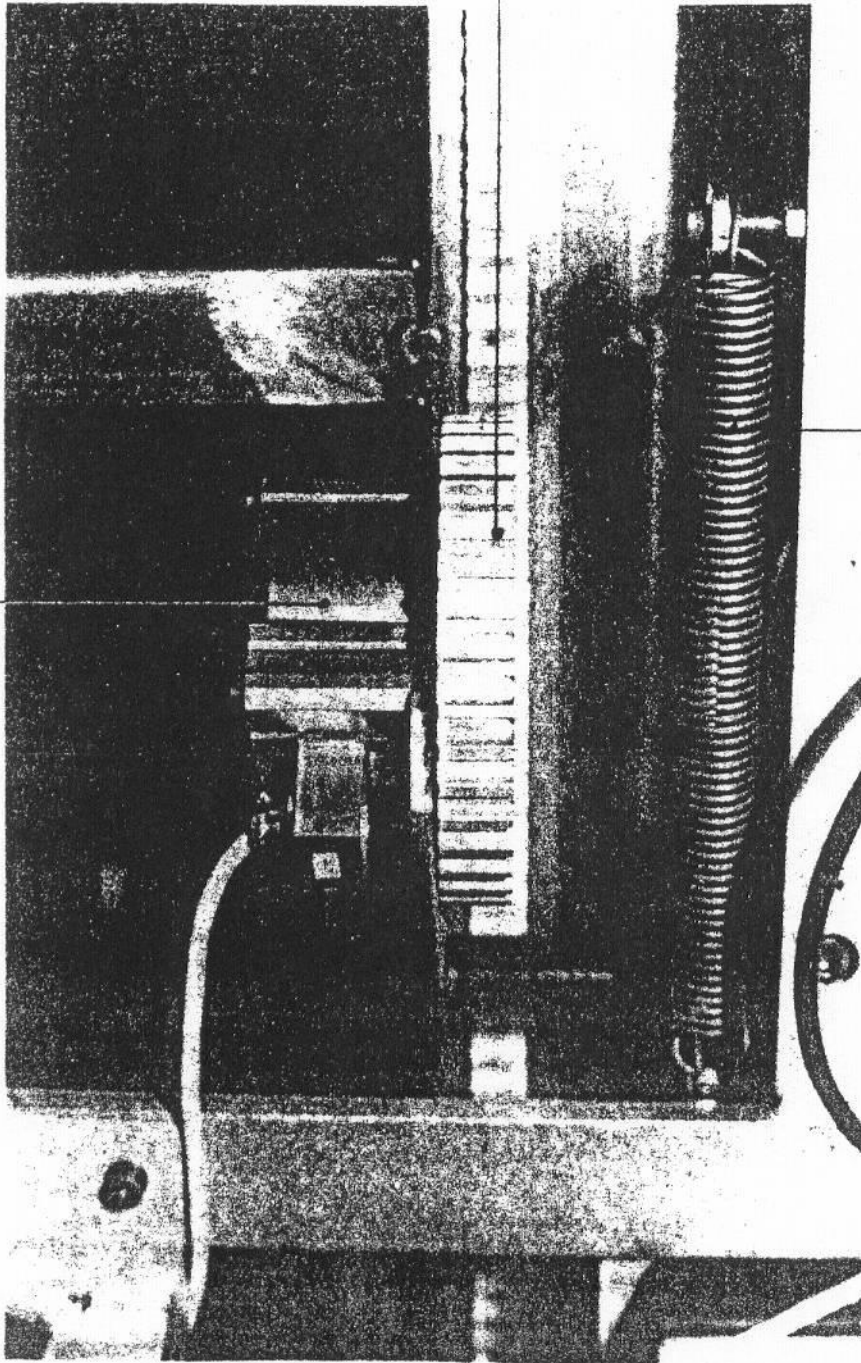

80328 Zugfeder

12459
Impulsgeber

80412 Ritzellager
5387 Rillenkugellager

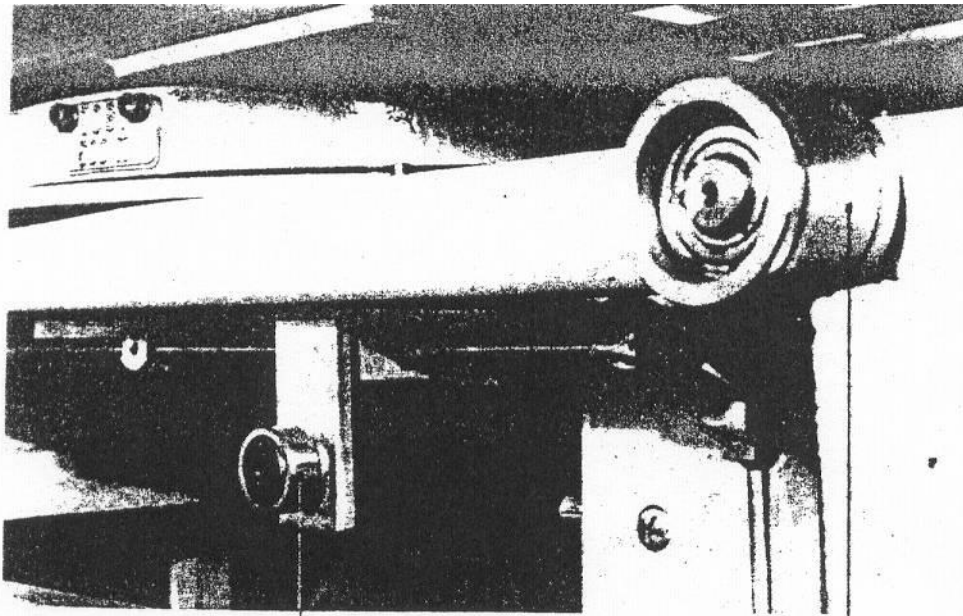

7973 Kurvenrolle

80 091 Laufrad

5392 Kugellager 6203 ZZ

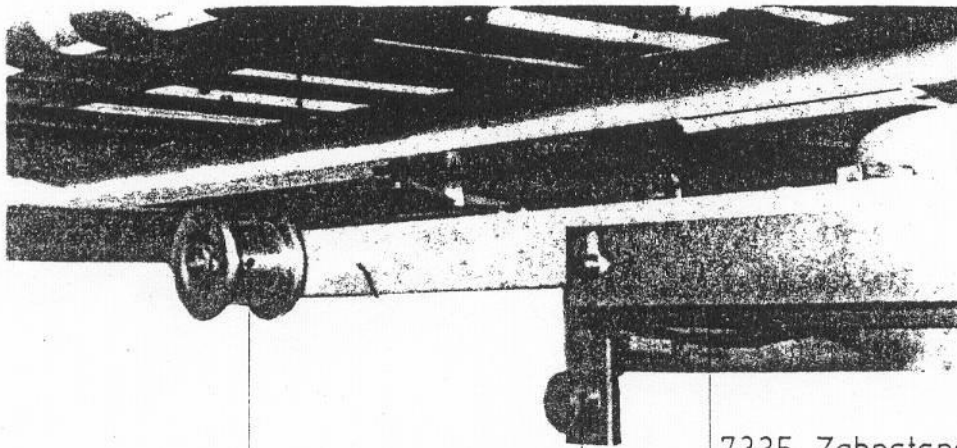

80 092 Spurkranzrad

5392 Kugellager 6203 ZZ

7335 Zahnstange

80321 Zahnrad

7973 Kurvenrolle

11824 Streifenbänder

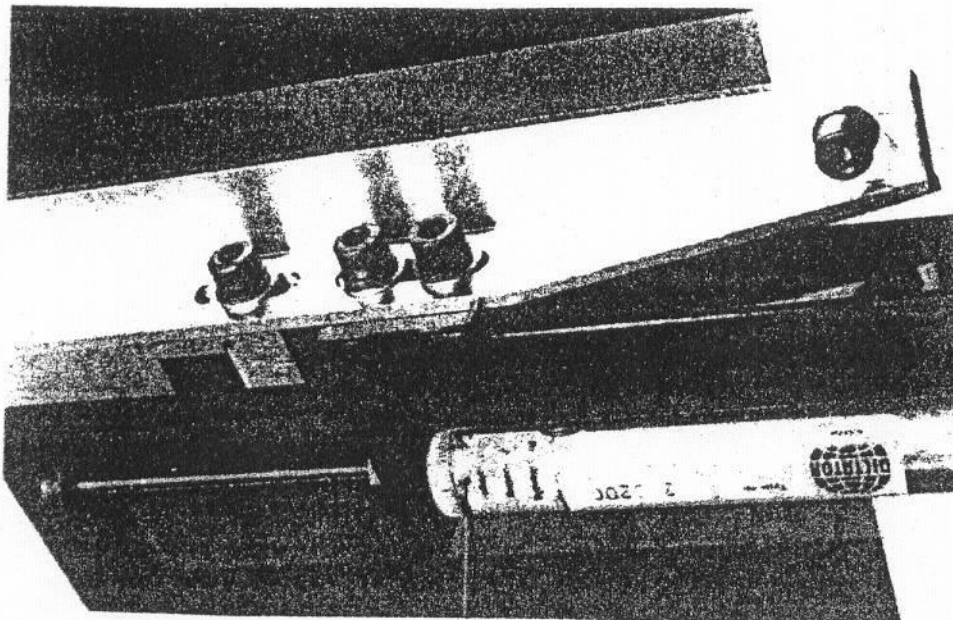
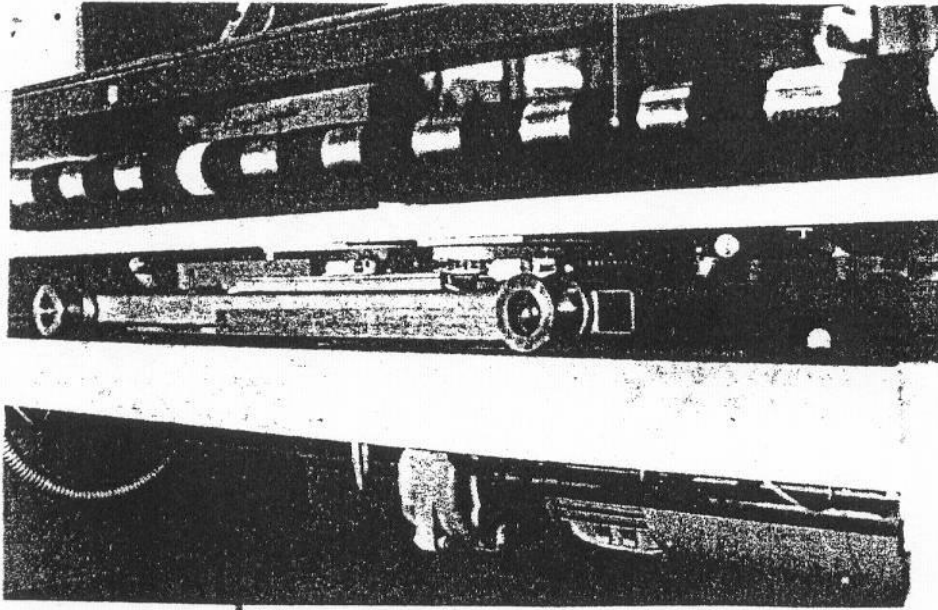

12184 Dämpfer

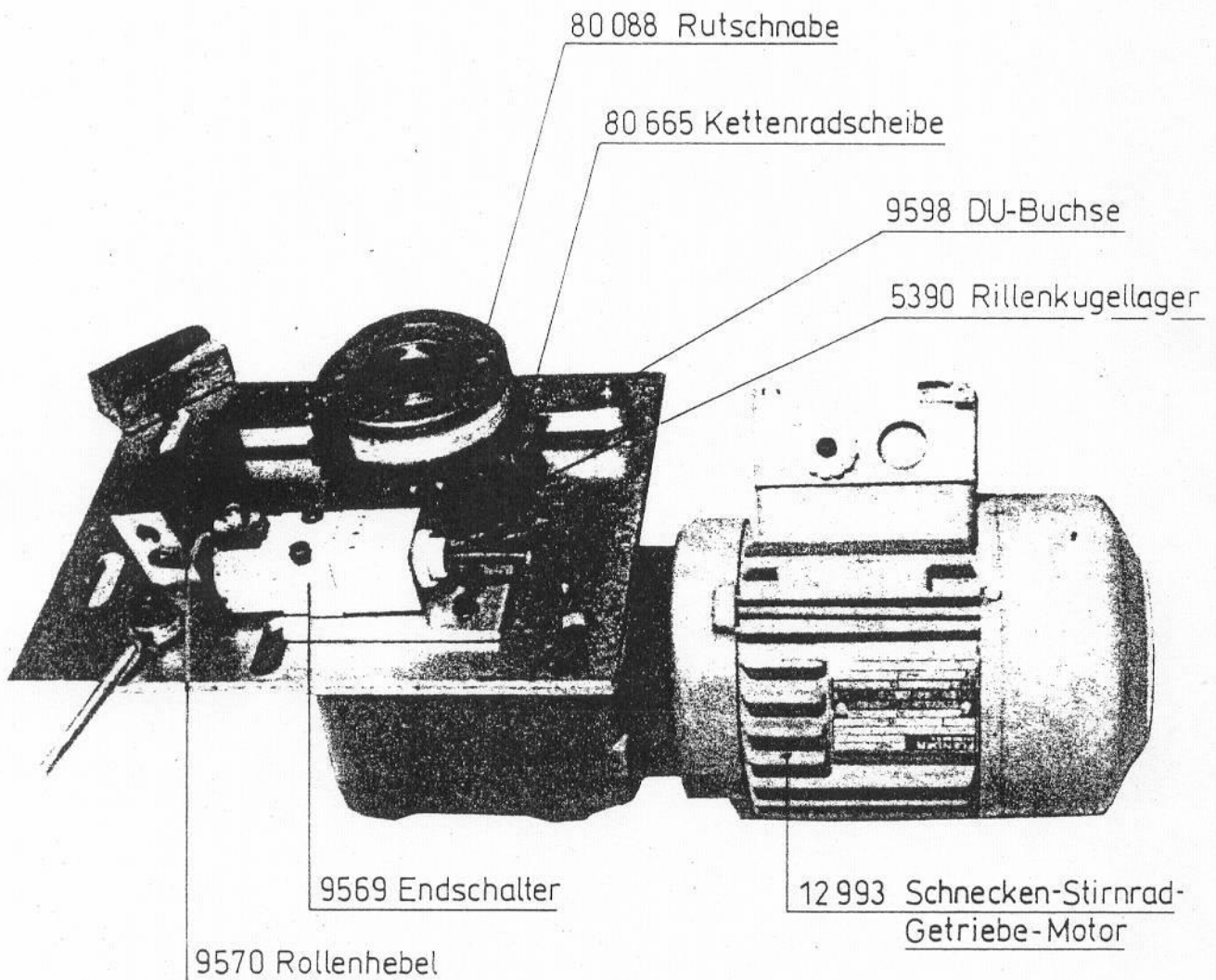

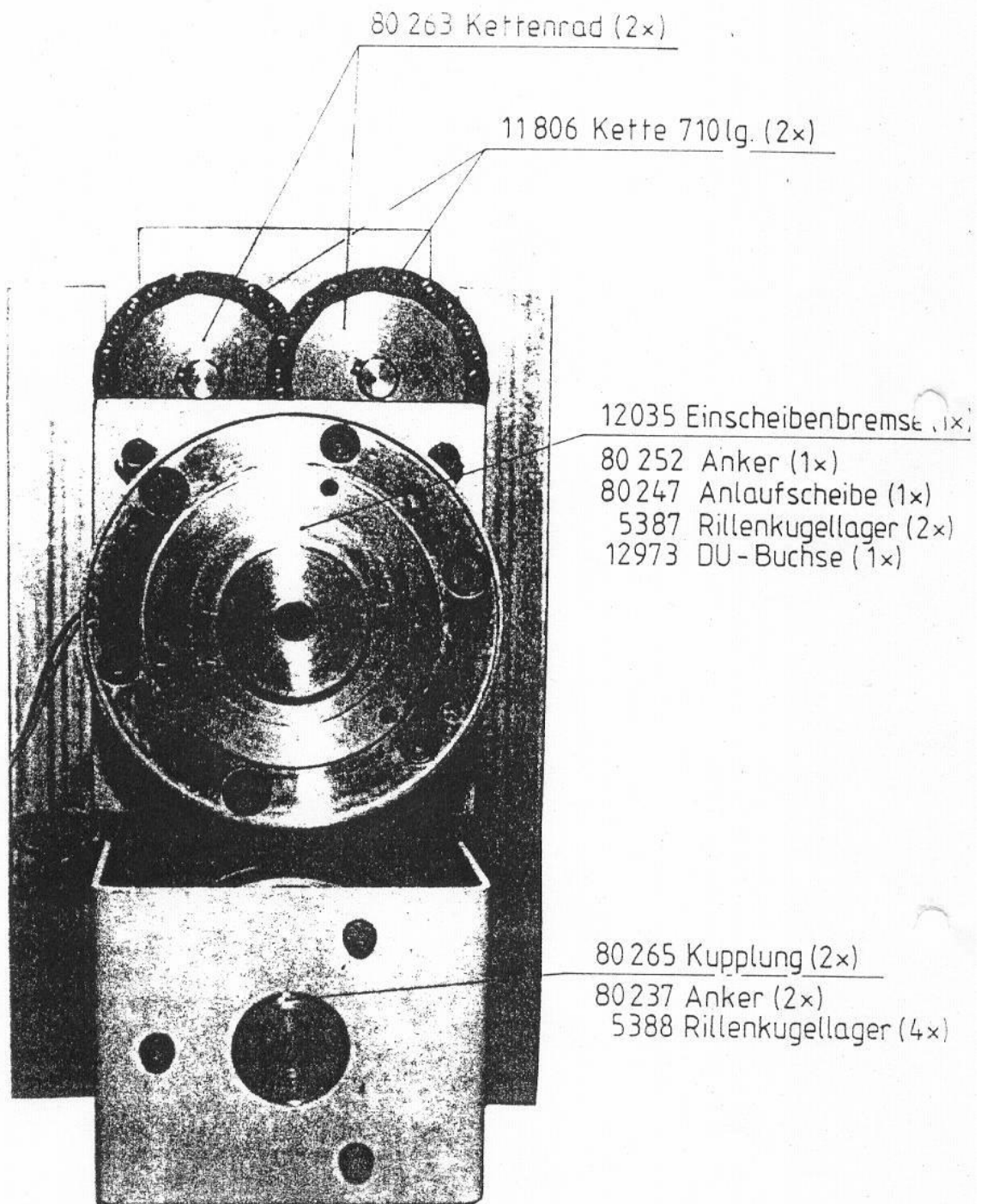

80 258 Zahnrad (2x)

5387 Rillenkugellager (4x)

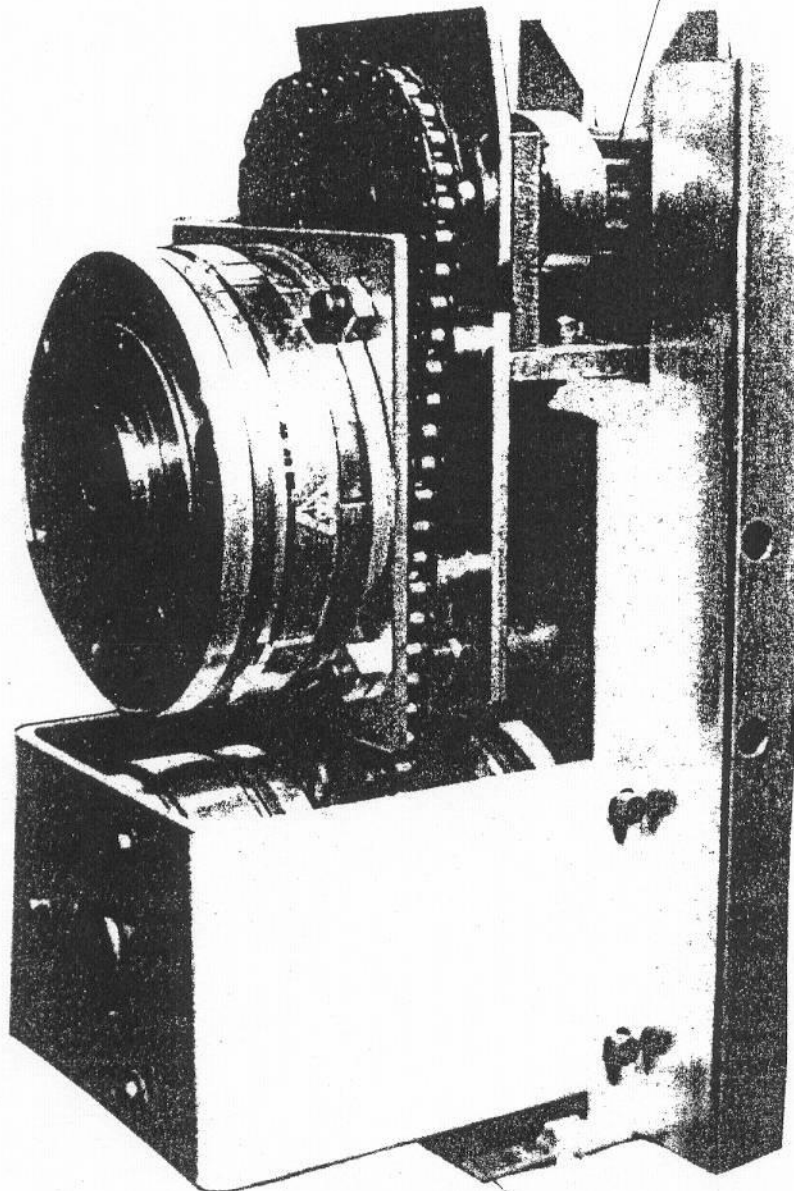

12 976 Gleichstrommotor (1x)

80 243 Kettenrad (1x)

9 095 Kette 600 la. (1x)

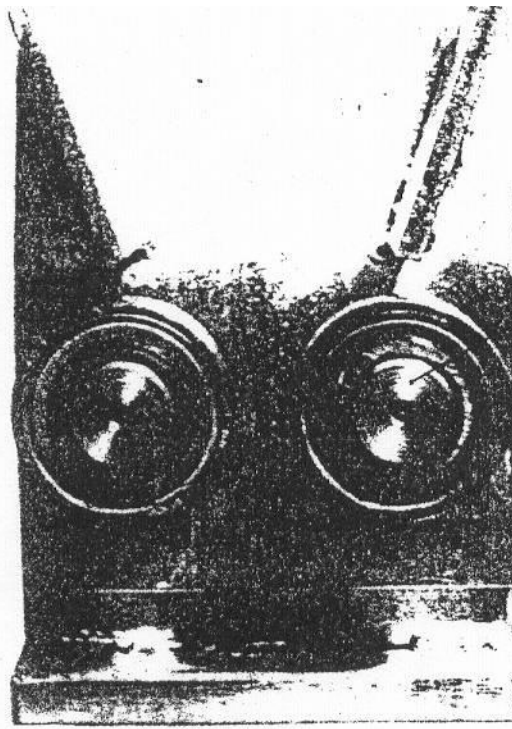

80 269 Laufradbolzen (2x)
5 389 Rillenkugellager (2x)

12 980 Einquadranten-Verstärker (1x)

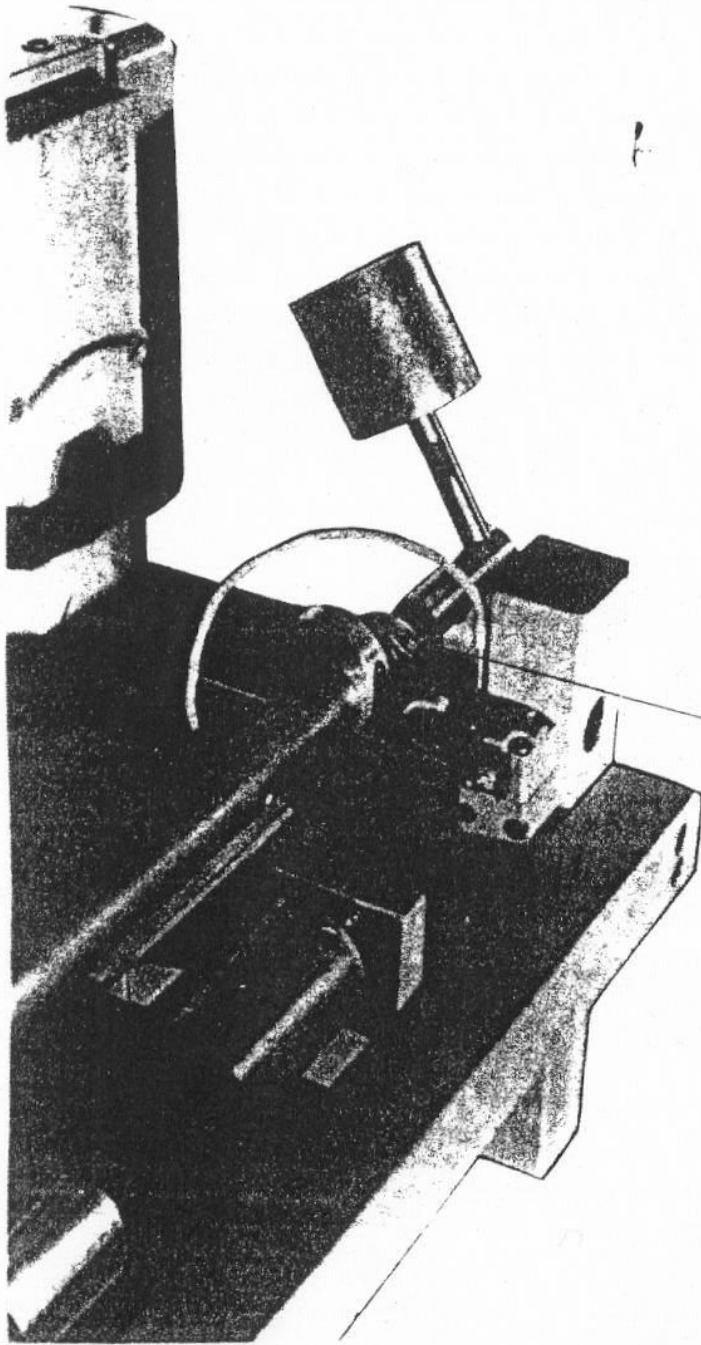
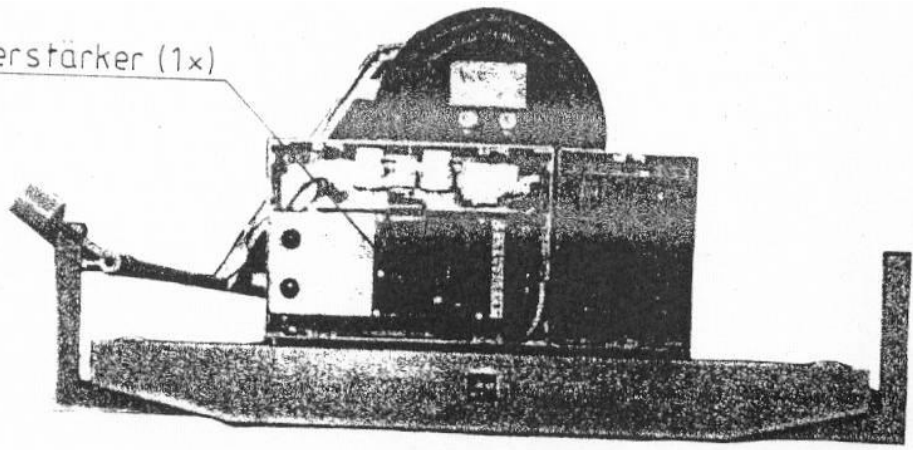

12 422 Gelenkkopf (2x)

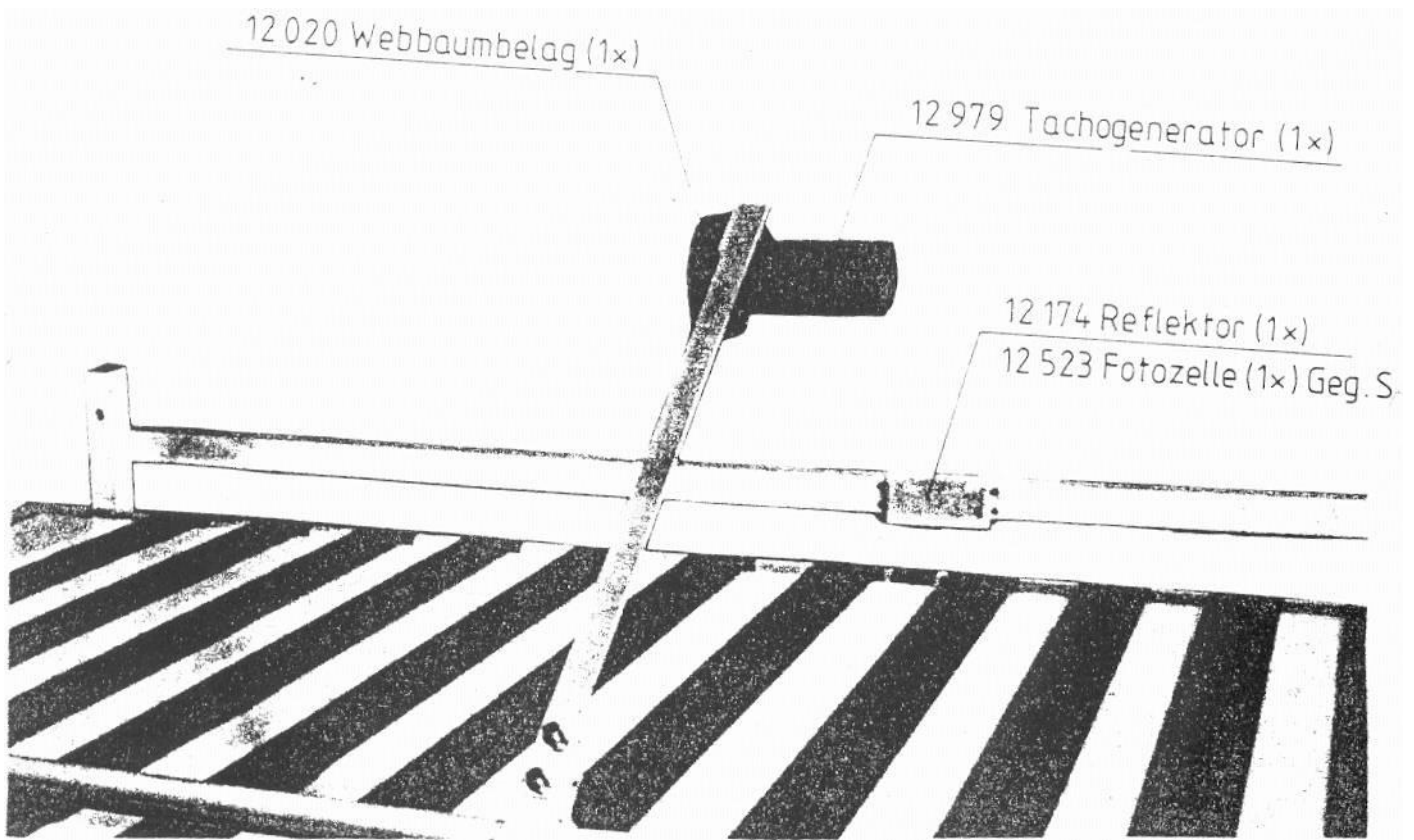

80 543 Zahnscheibe (2x)

12 944 Zahnriemen

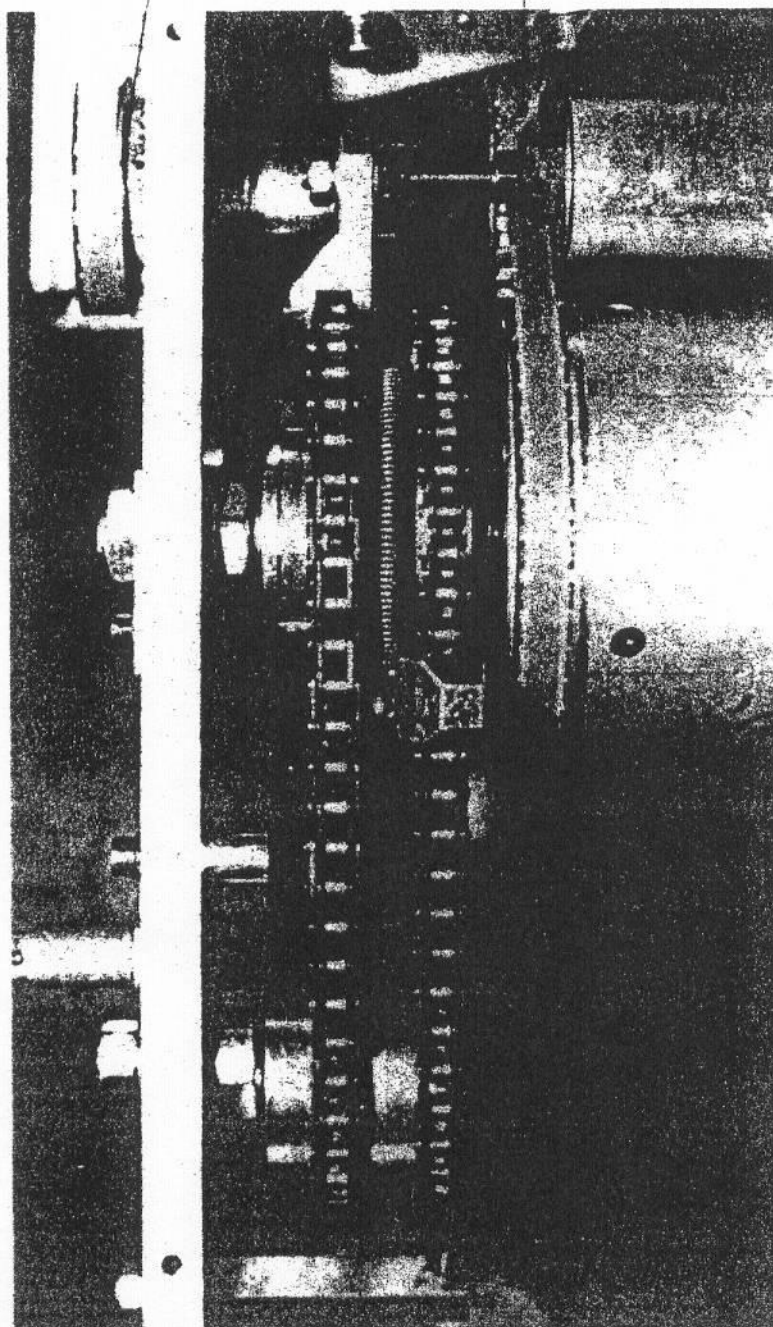

80 045 Zahnscheibe (1x)

5 385 Rillenkugellager (2x)

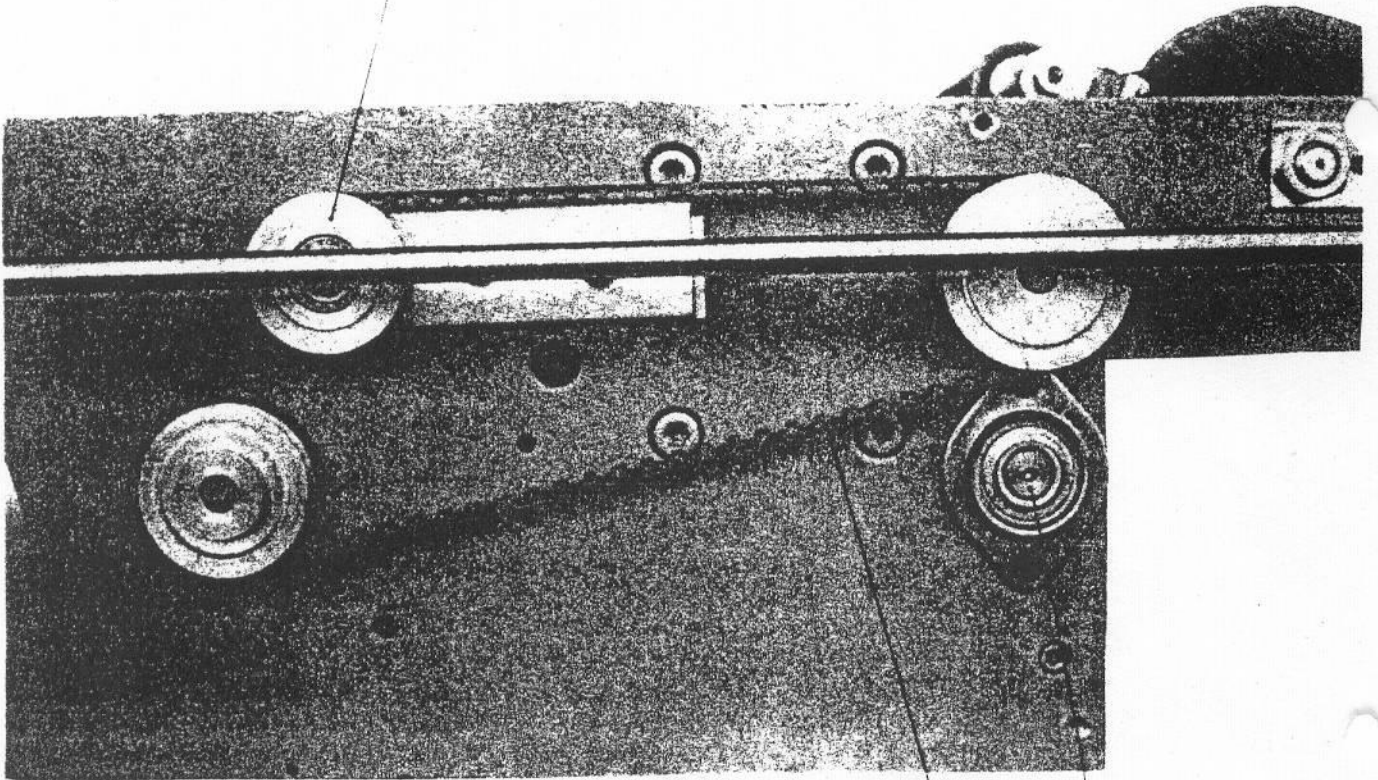

12 987 Zahnriemen 780 lg. (1x)

7664 Flanschlager (2x)

38 935 Wellengelenk (1x)

80 366 Kettenrad (1x)

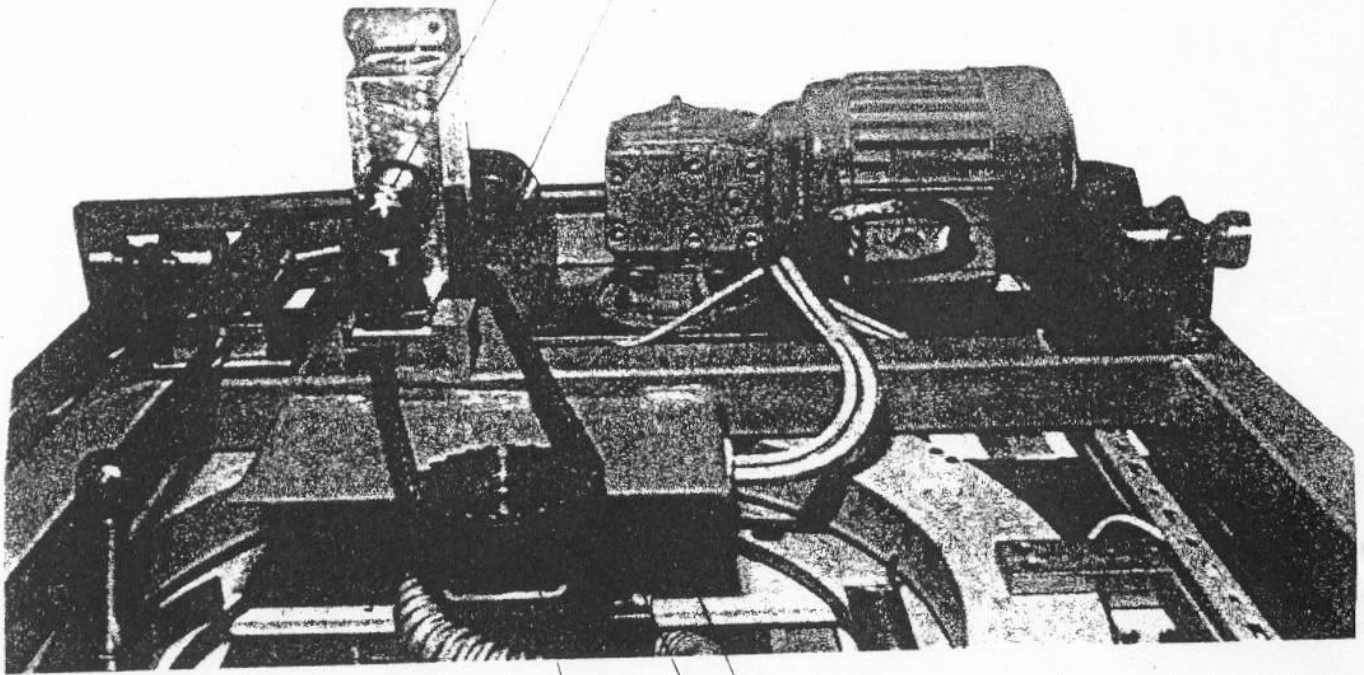

80 140 Kettenrad (1x)

6392 Federverschlußglied (1x)

12 989 Winkelgetriebe (1x)

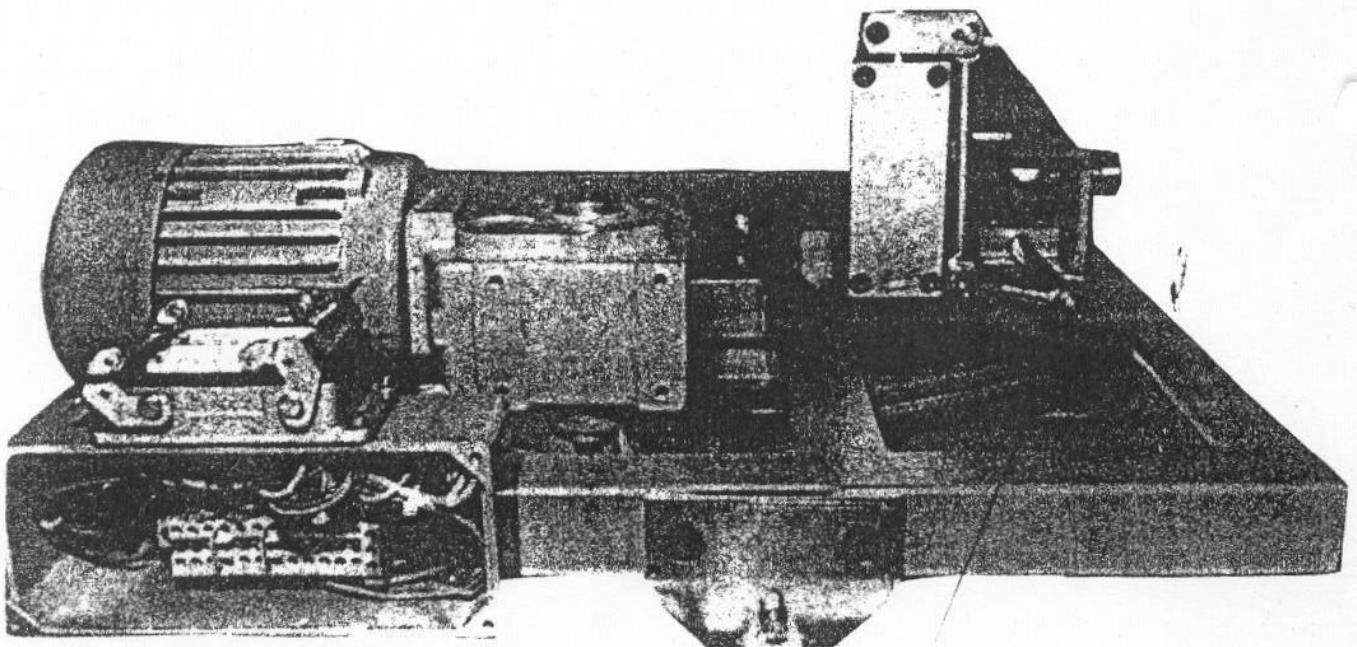

7329 Rillenkugellager (1x)

80 281 Kettenrad (1x)

6387 Rollenkefite (2x)

7329 Rillenkugellager (2x)

6391 Verbindungsglied (1x)

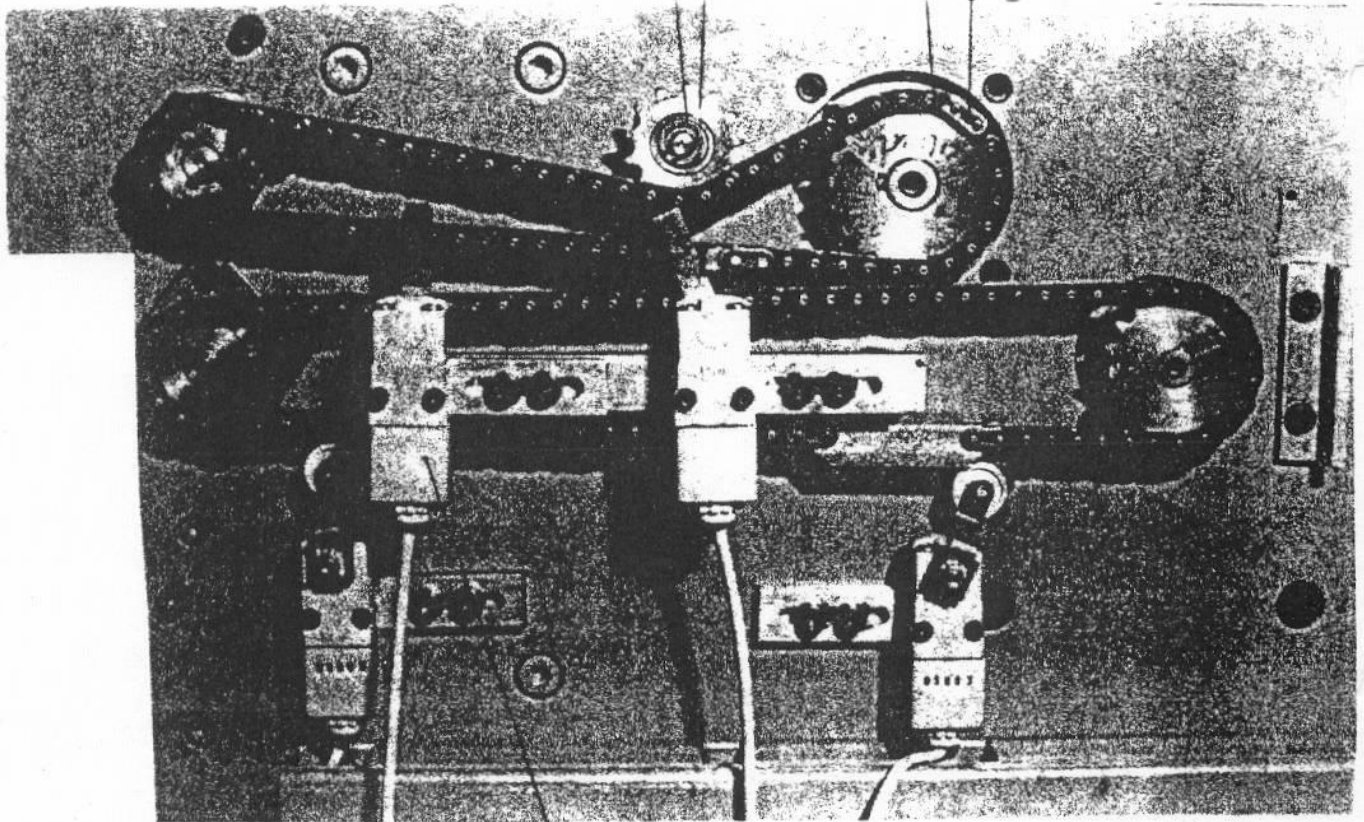

9569 Endschalter (4x)

80 272 Kettenrad (1x)

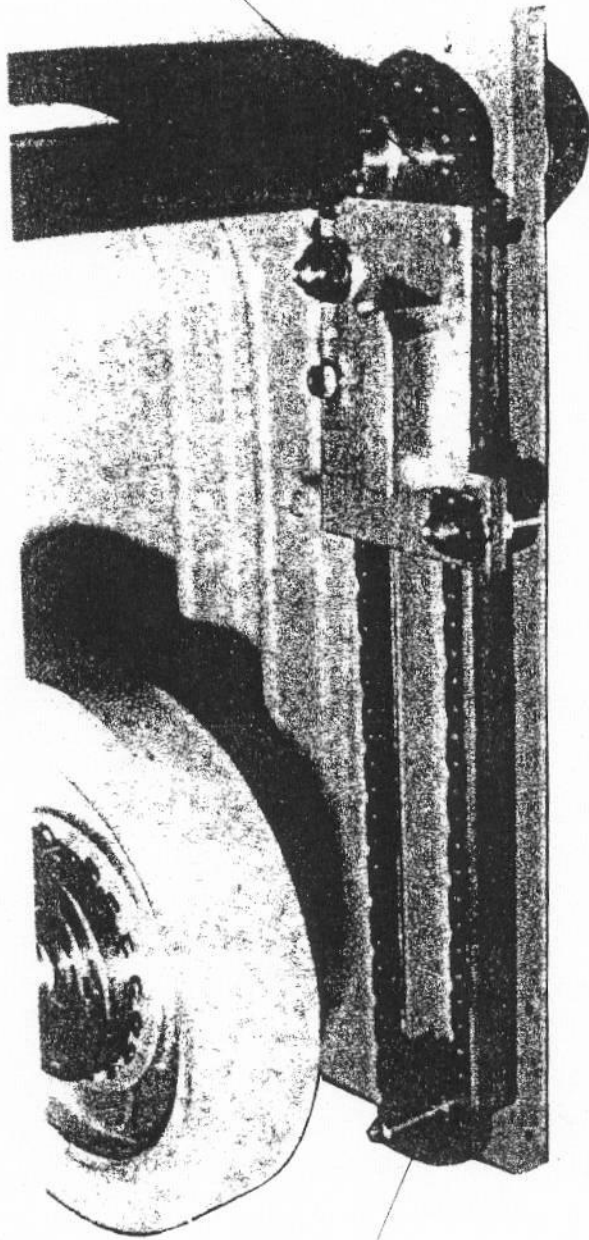

80 272 Kettenrad (1x)

80 136 Kupplung (1x)

12 013 Ankerplatte (1x)

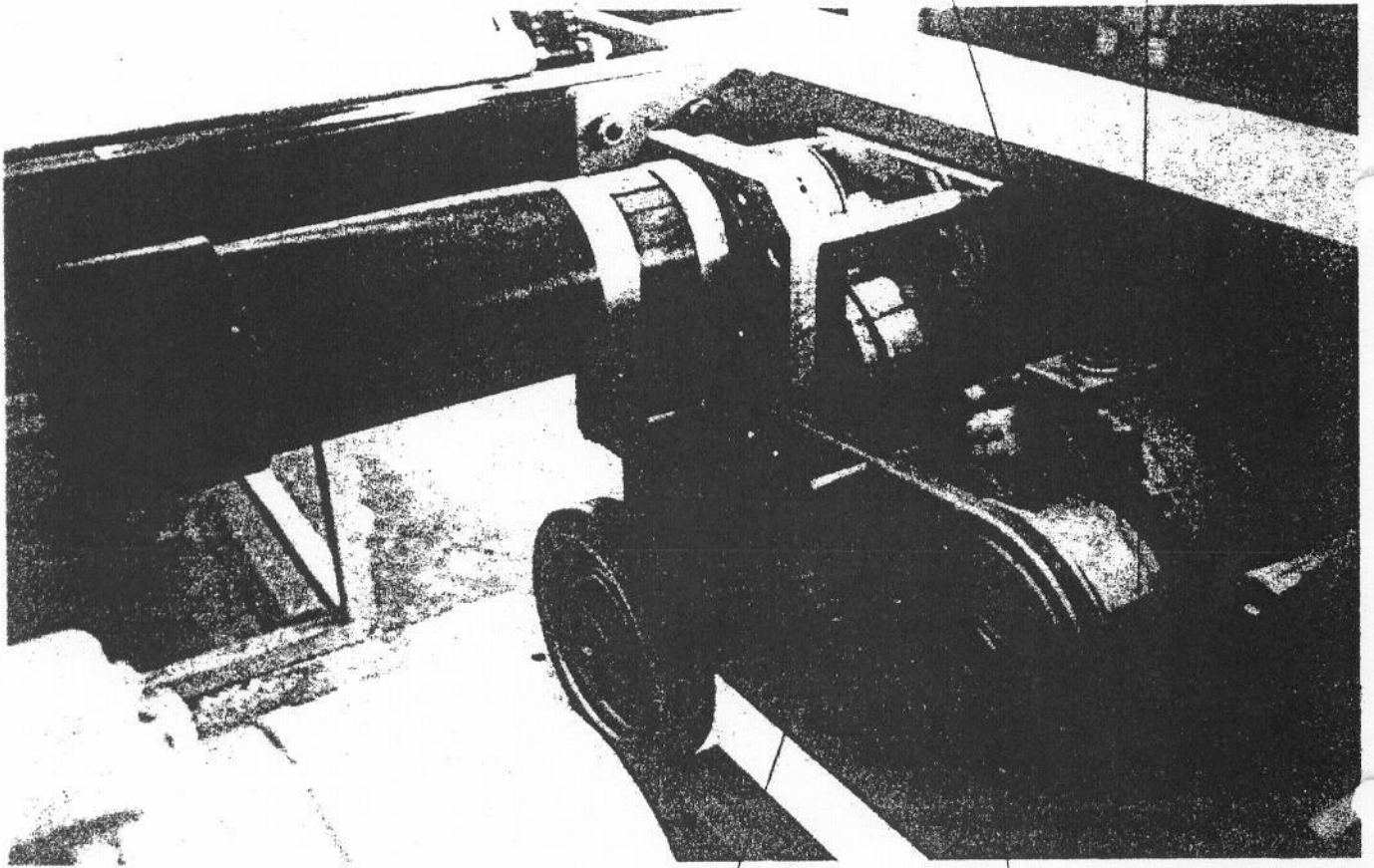

12 986 Zahnriemen 720 lg. (1x)

5388 Rillenkugellager (2x)

80 020 *Komplett*

80 024 Zahnscheibe

80 025 Zahnscheibe

80 029 Zahnscheibe

80 030 Zahnscheibe

80 035 Zahnscheibe

12 949 Freilauf

5389 Rillenkugellager

5391 Rillenkugellager

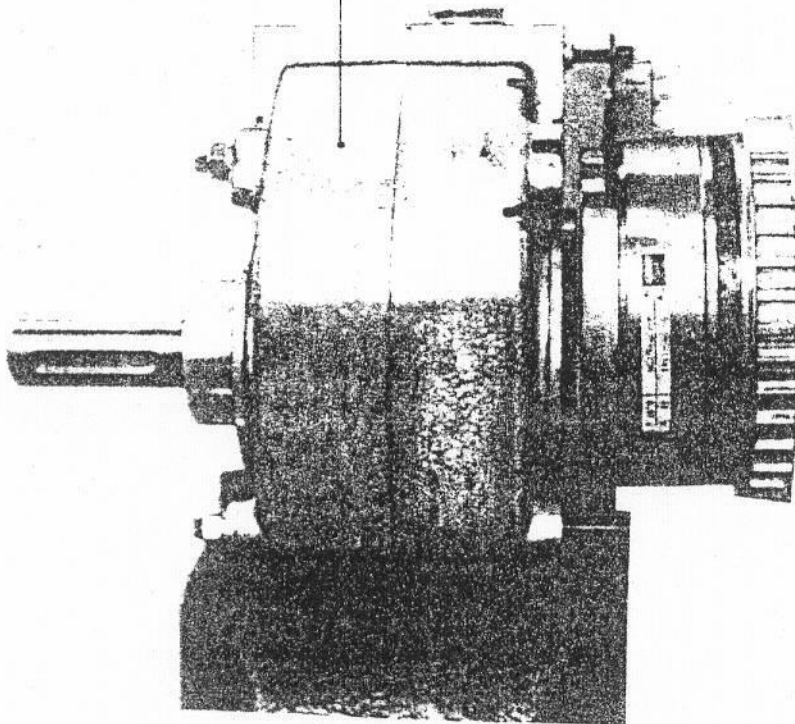

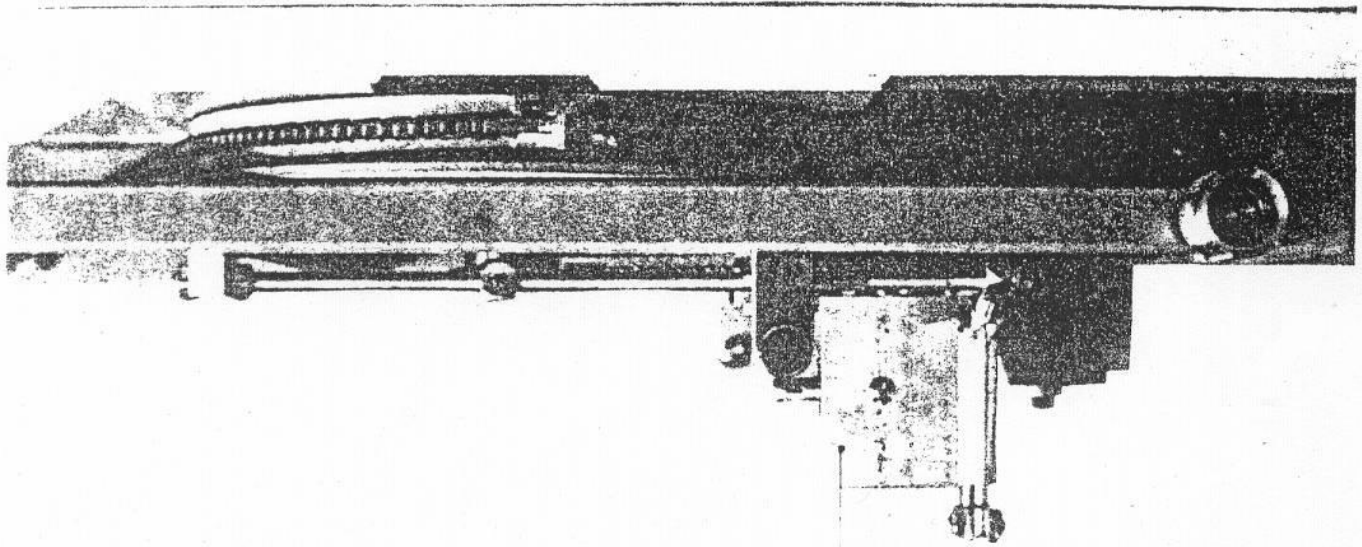

16 747 Kegelrad

16 767 Kegelrad

3893 Büro-Wellengelenk

5391 Rillenkugellager 6202 ZZ

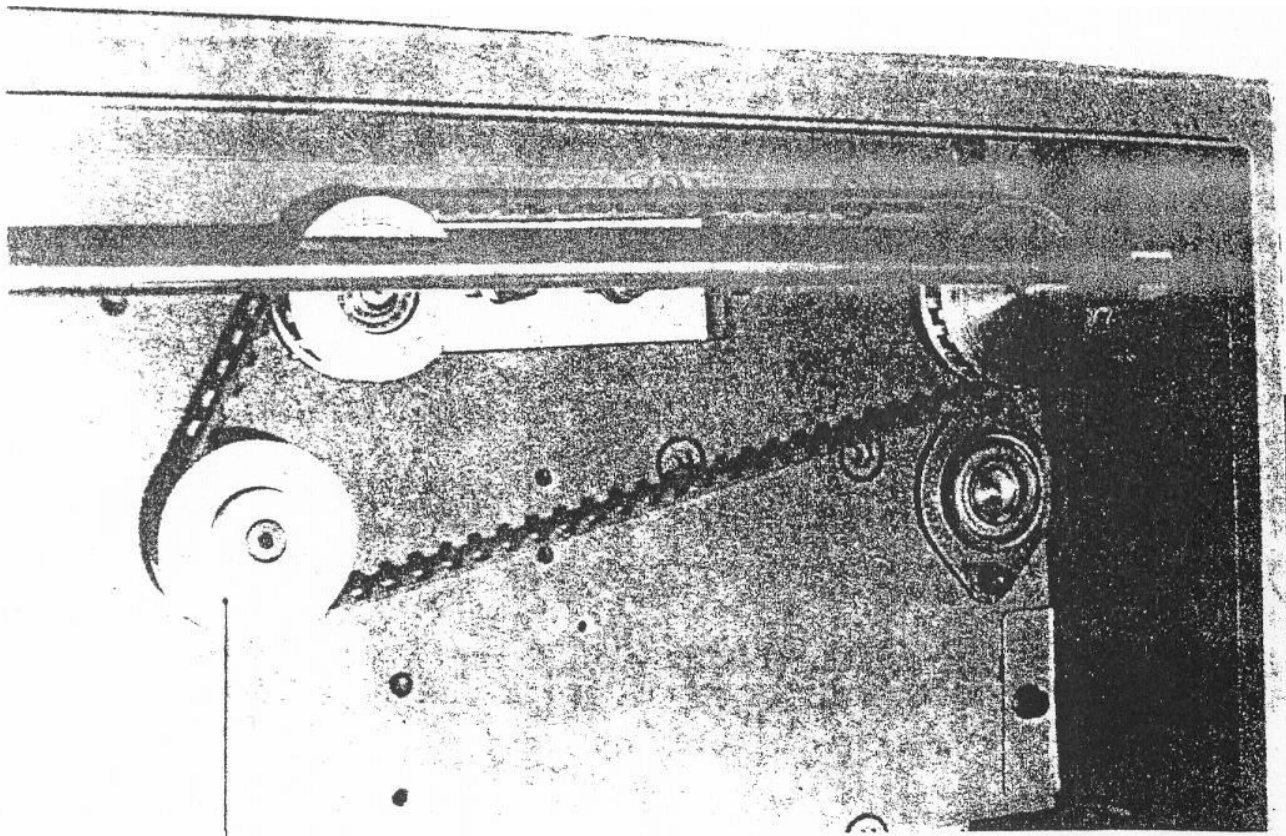

80 227 Zahnscheibe

80 222 Zahnscheibe
5388 Rillenkugellager 6003 ZZ

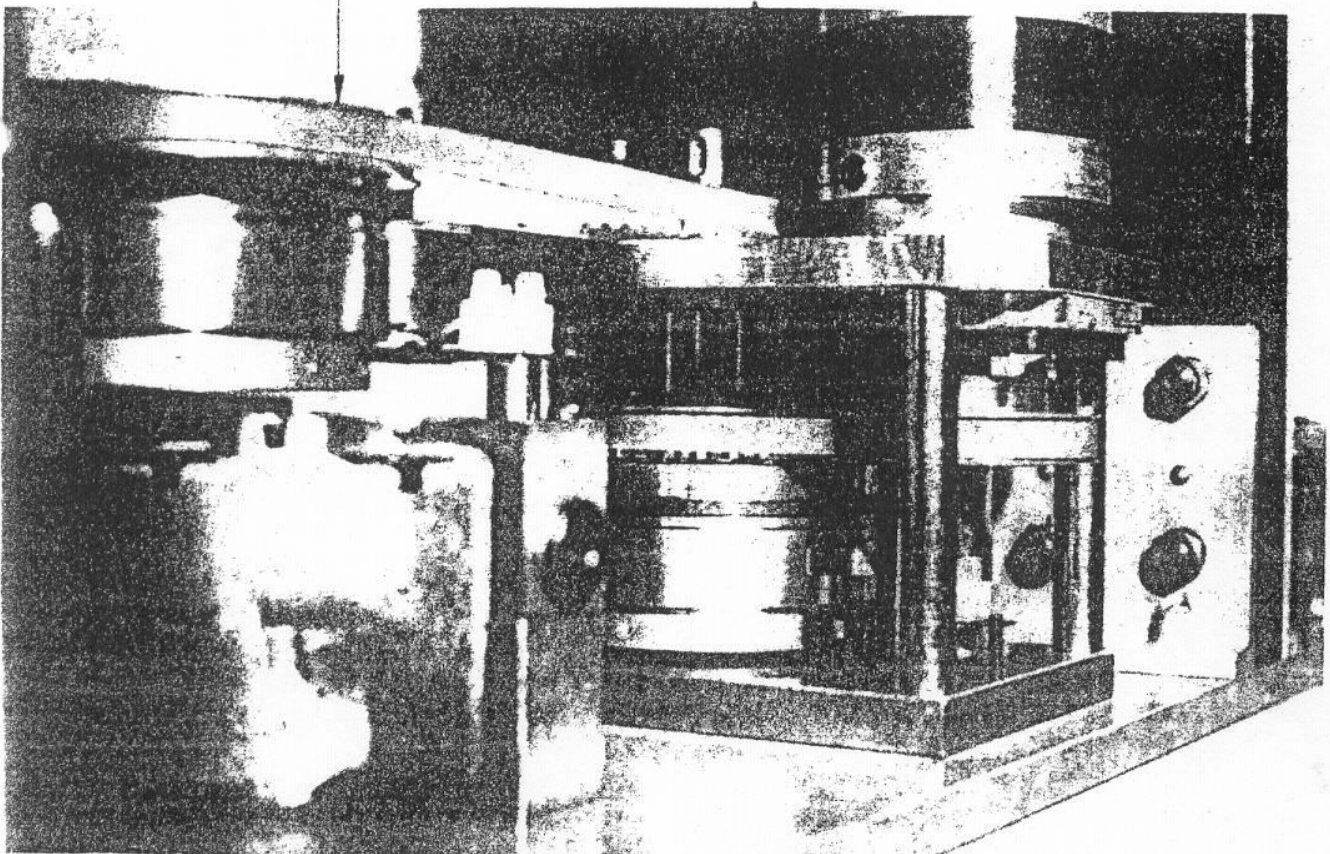

12 969 Wendeaufschlag

12 968 Regler

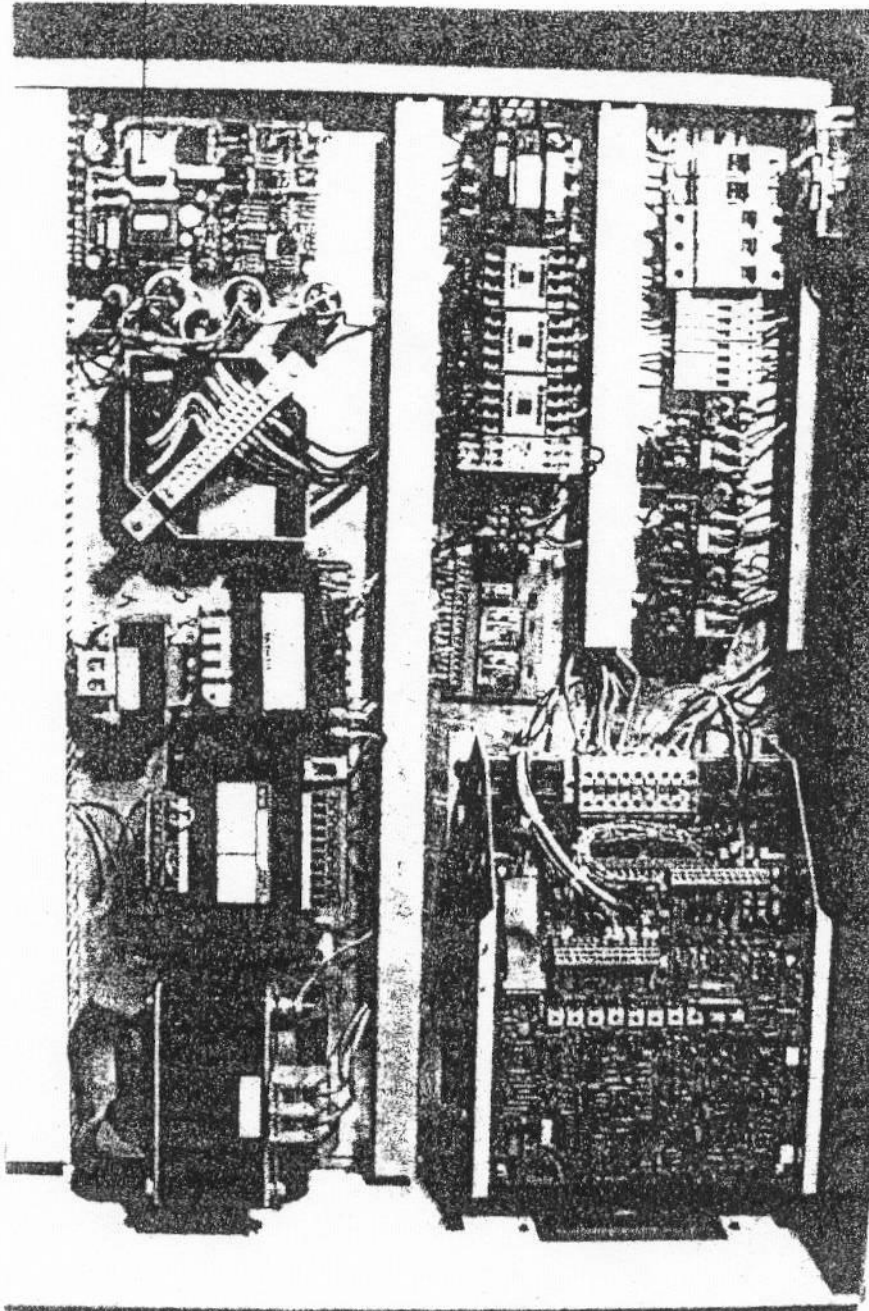

12 967 Einfädelmotor

12 971 Zahnriemen

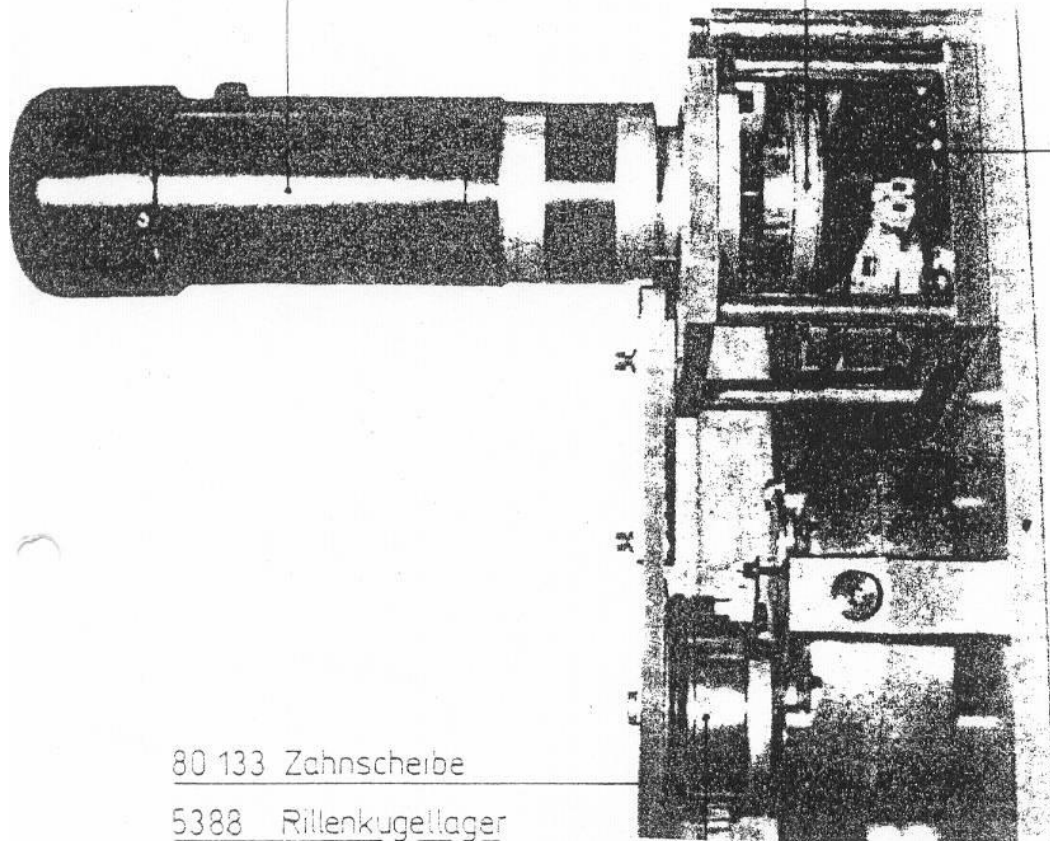

80 122 Zahnscheibe

80 133 Zahnscheibe

5388 Rillenkugellager
6003 ZZ

80 134 Kupplung

80 237 Anker

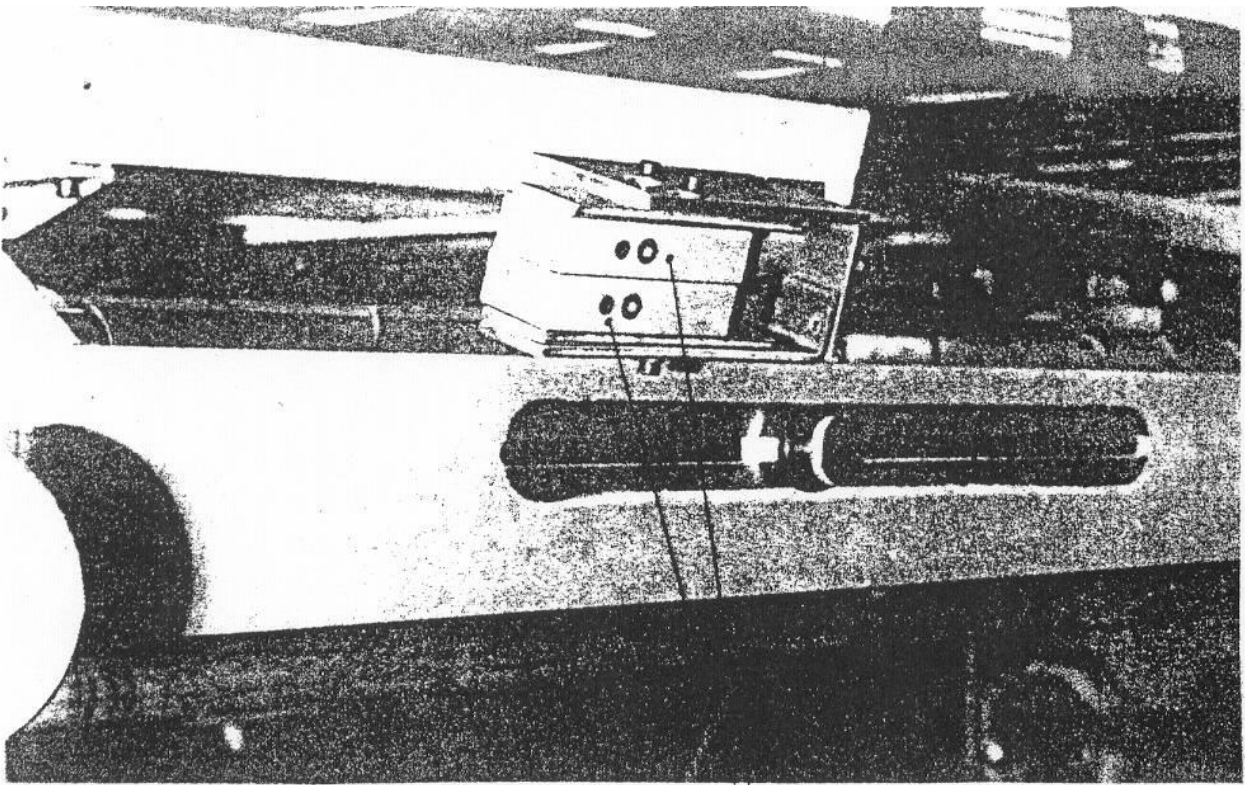

12 523 Fotozelle

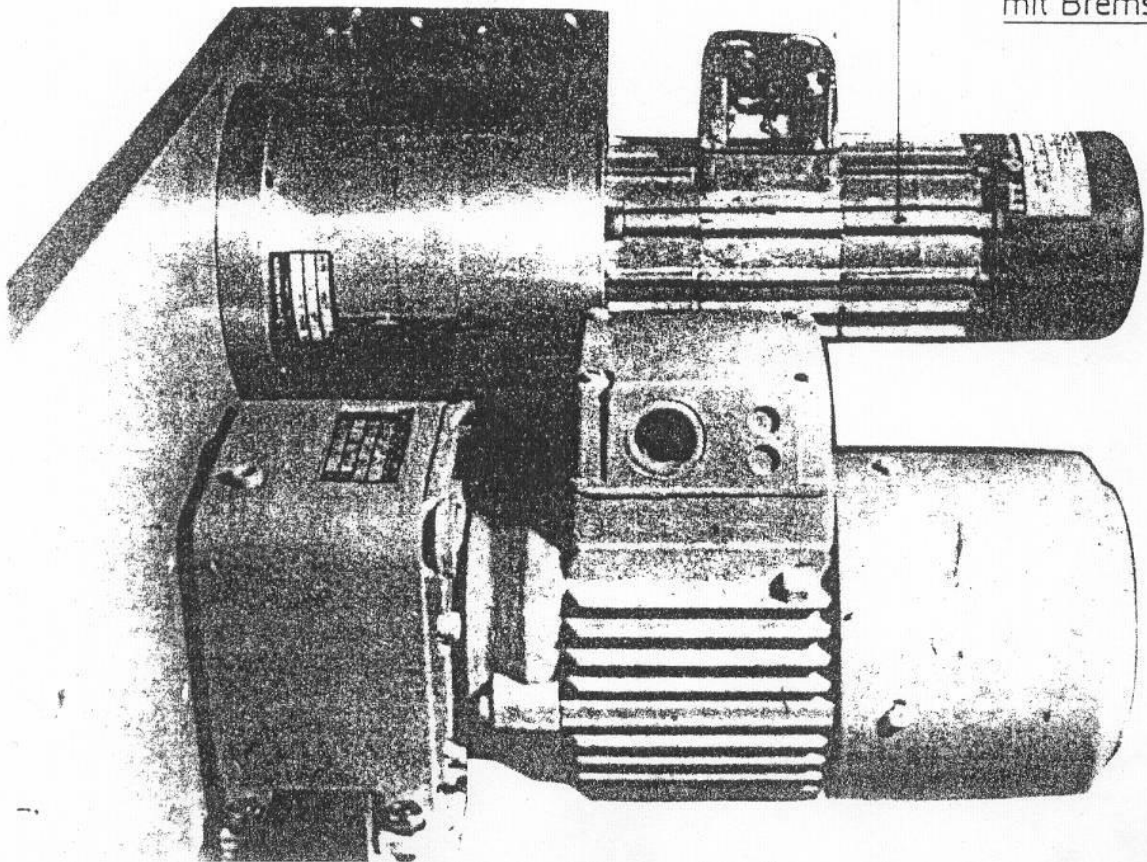

11 036 Drehstrommotor
mit Bremse

5387 Rillenkugellager

11806 Kette

12998 Verbindungsglied

5381

Kugellager 609 ZZ

12020

Rolltex grün

12939

Pendelkugellager

12942

Nadellager

80014

Zahnscheibe

80079

Kettenrad

12940

Konus Spannelement

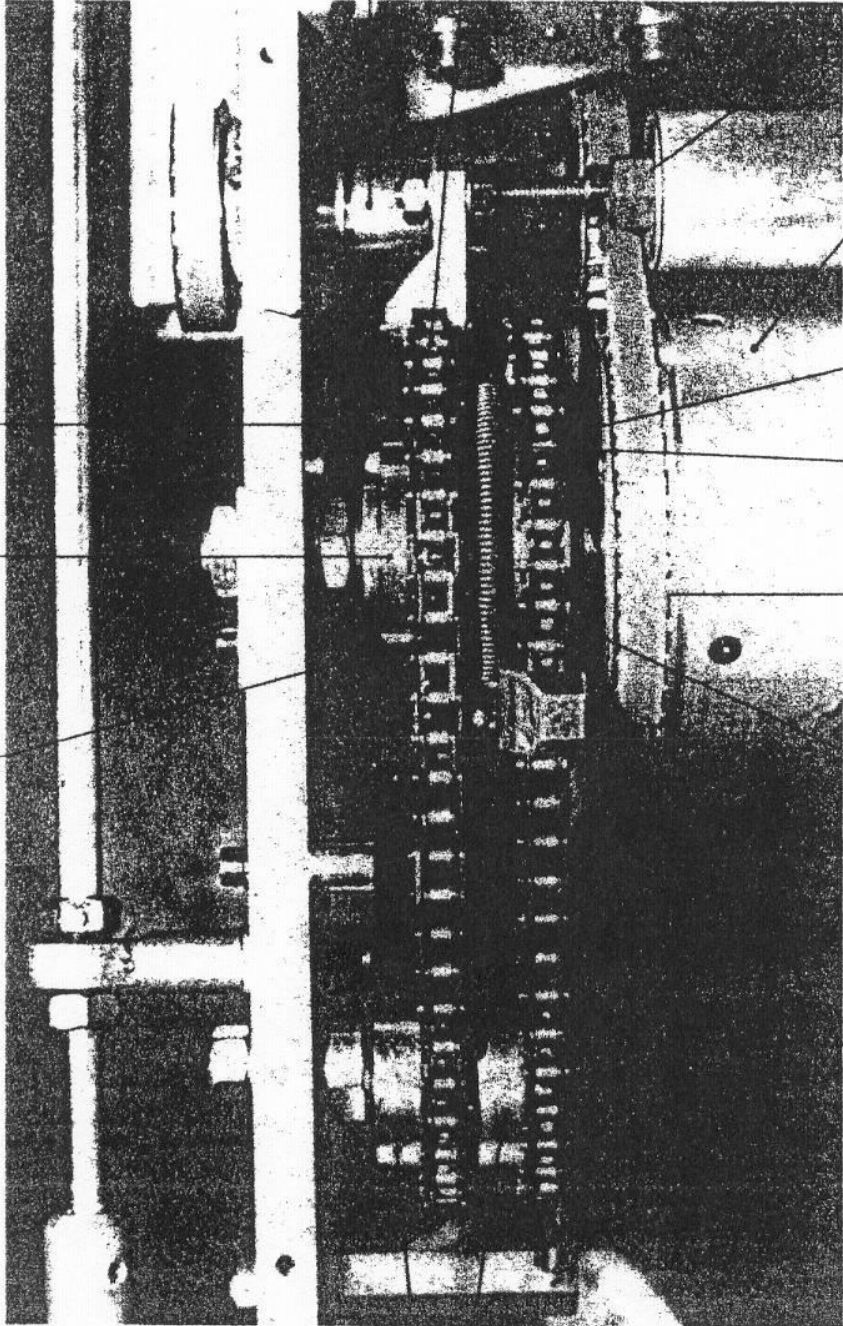

0077

Kettenrad

0077

Nachse

1430

0

Kugelfeder

80037 Kettenrad

12 982 Varioverstellscheibe

12 422 Gelenklager

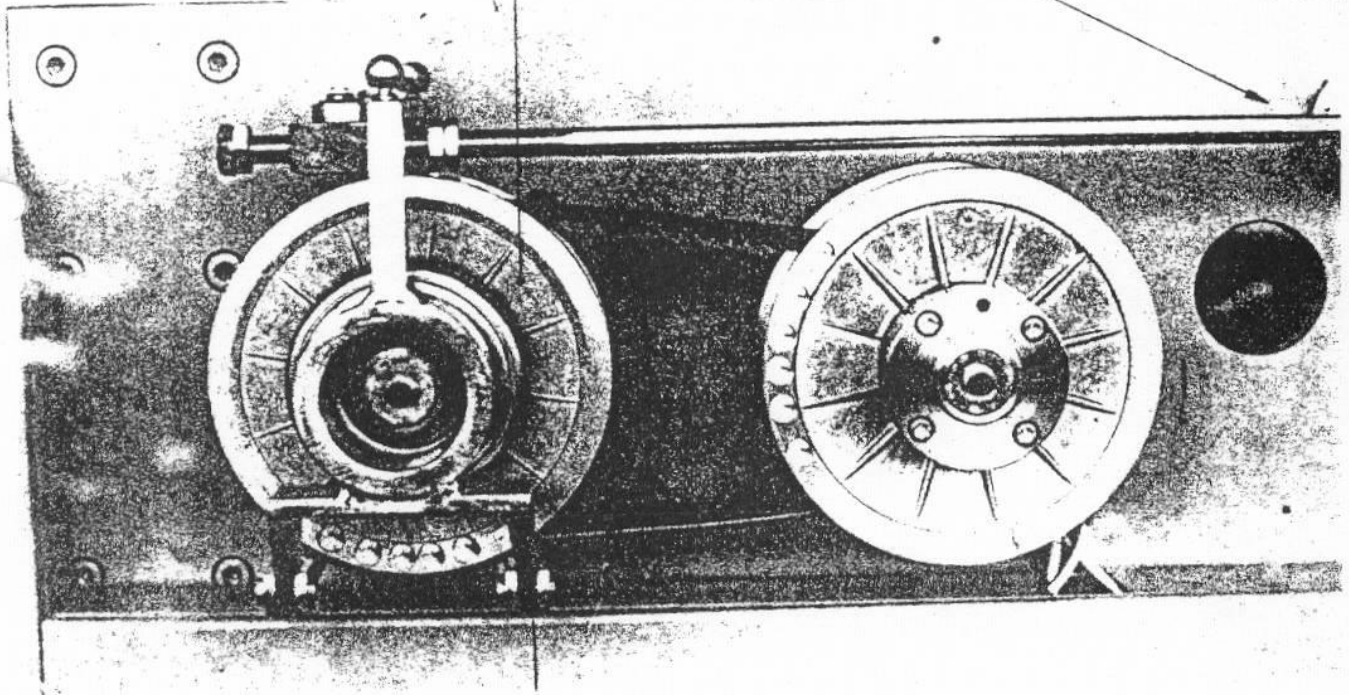

9571 Endschalter (1x)

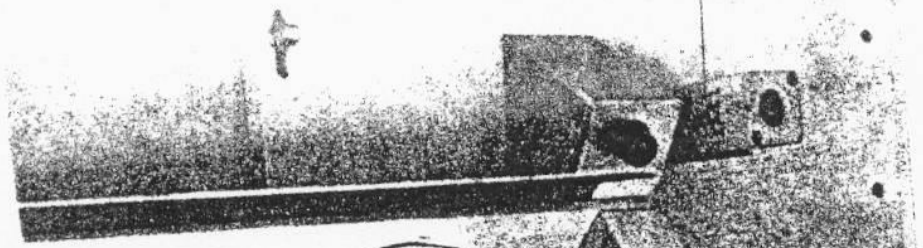

9569 Endschalter (2x)
9570 Rollenhebel (2x)

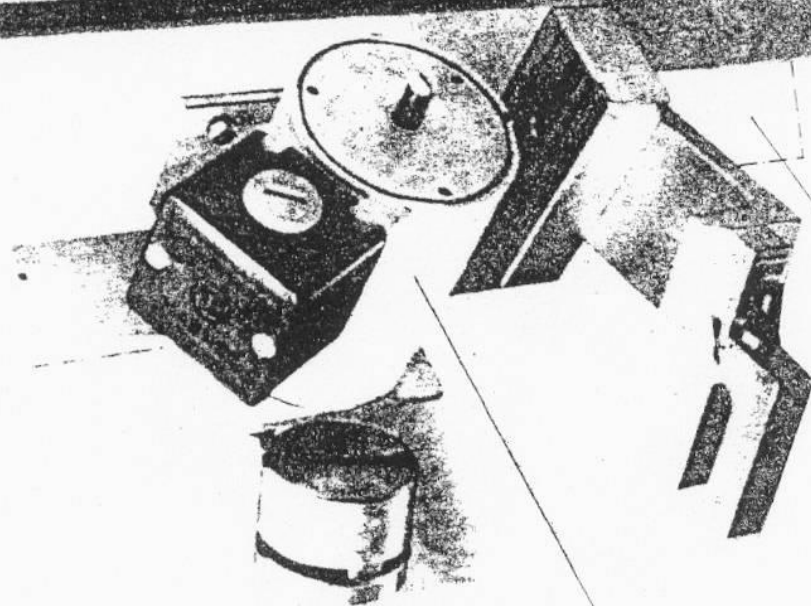

12 977 Hubmagnet (2x)

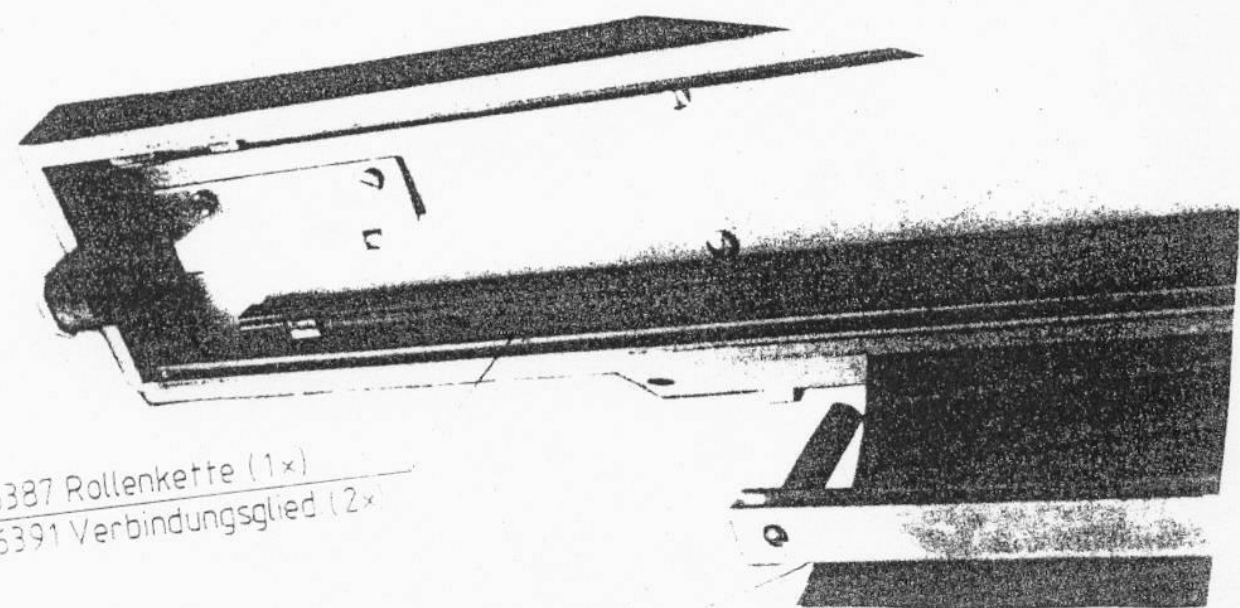

6387 Rollenkette (1x)
6391 Verbindungsglied (2x)

11 006 KLETTGERÄT

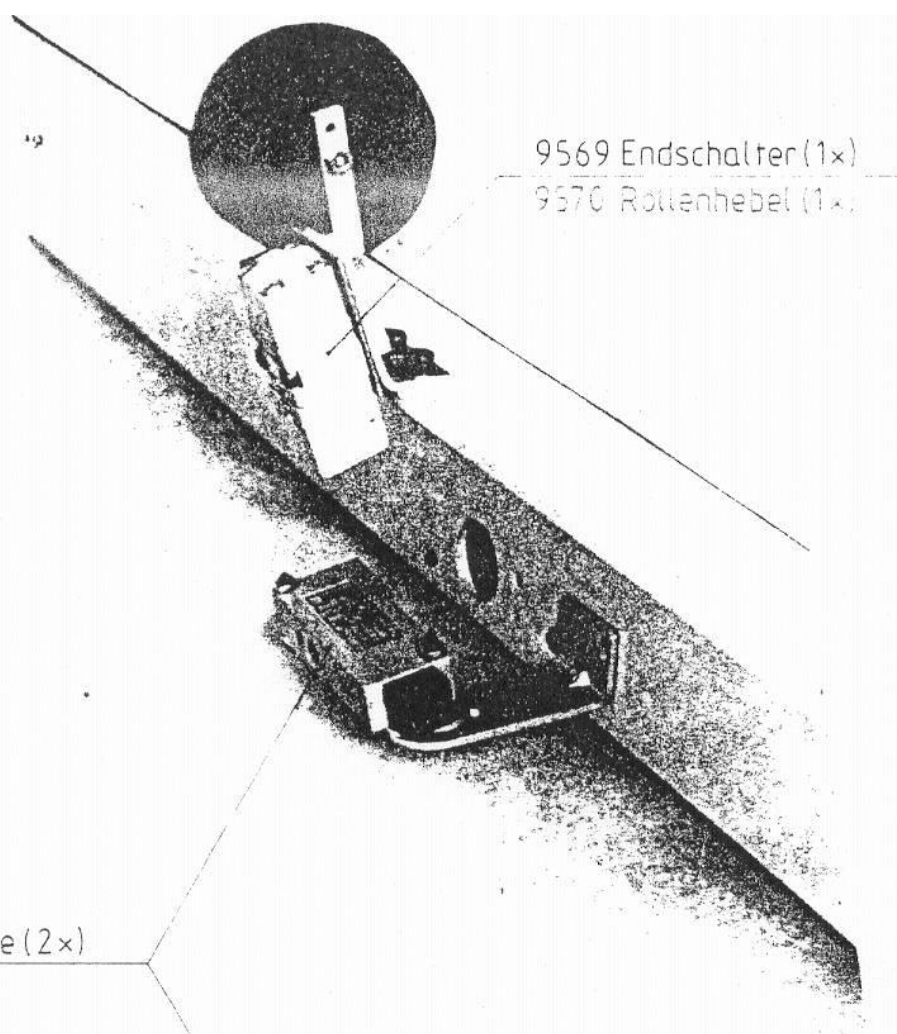

9569 Endschalter (1x)
9570 Rollenhebel (1x)

11 586 Fotozelle (2x)

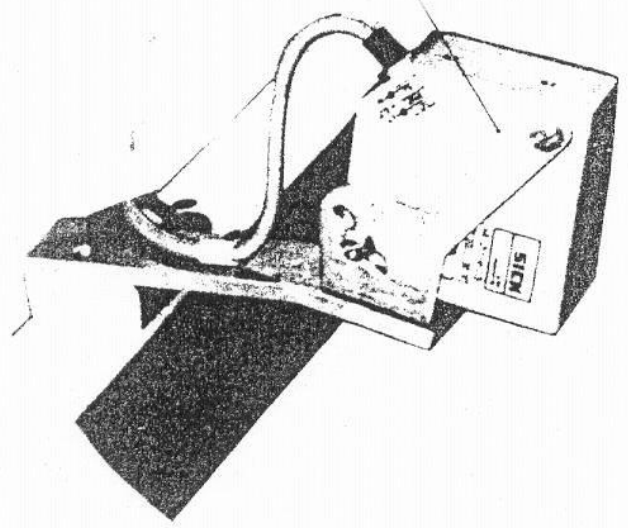

11 410 Zahnriemen (1x)

80 191 Zahnscheibe (1x)

5 387 Rillenkugellager (3x)

12 046 Stromabnehmer (2x)

80 727 Zahnscheibe (1x)

80 693 Ritzel (1x)

80 658 Feder (1x)

12 962 Laufrolle (4x)

80 692 Umlenkrad (3x)

7 329 Rillenkugellager (3x)

80 199 Zahnscheibe (1x)

80 726 Zahnscheibe (1x)

5 386 Rillenkugellager (2x)

7 329 Rillenkugellager (2x)

97 824 Rundmesser (1x)

11 413 Zahnriemen (1x)

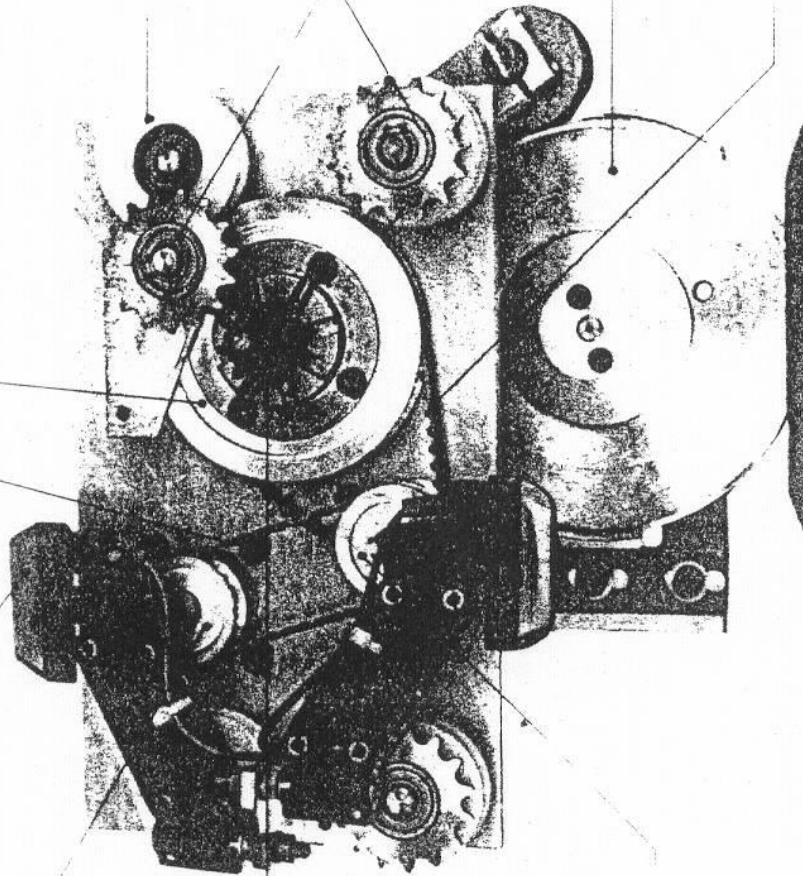

12 959 Motor (1x)

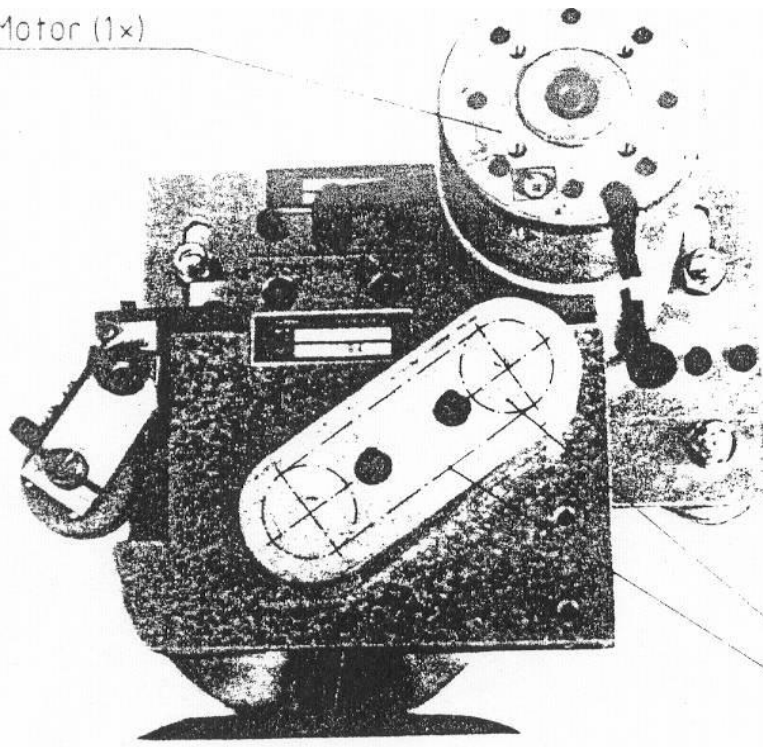

80 204 Zahnscheibe (2x)
12 957 Zahnriemen (1x)

12 960 DU - Buchse (2x)

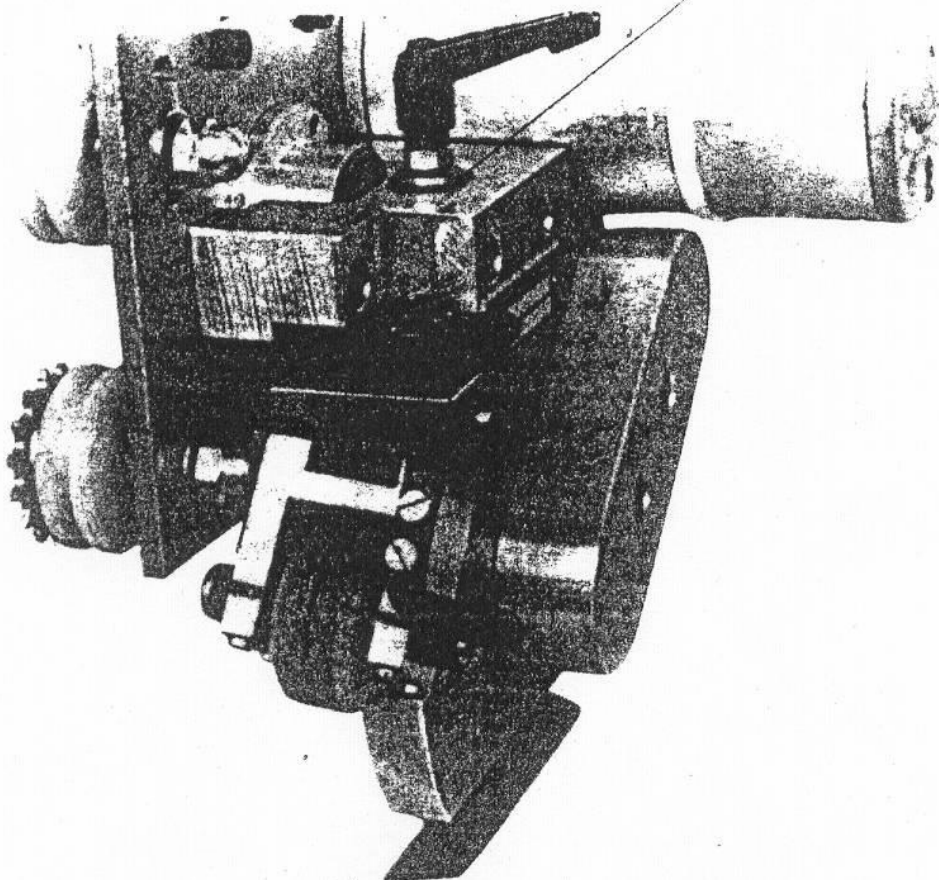

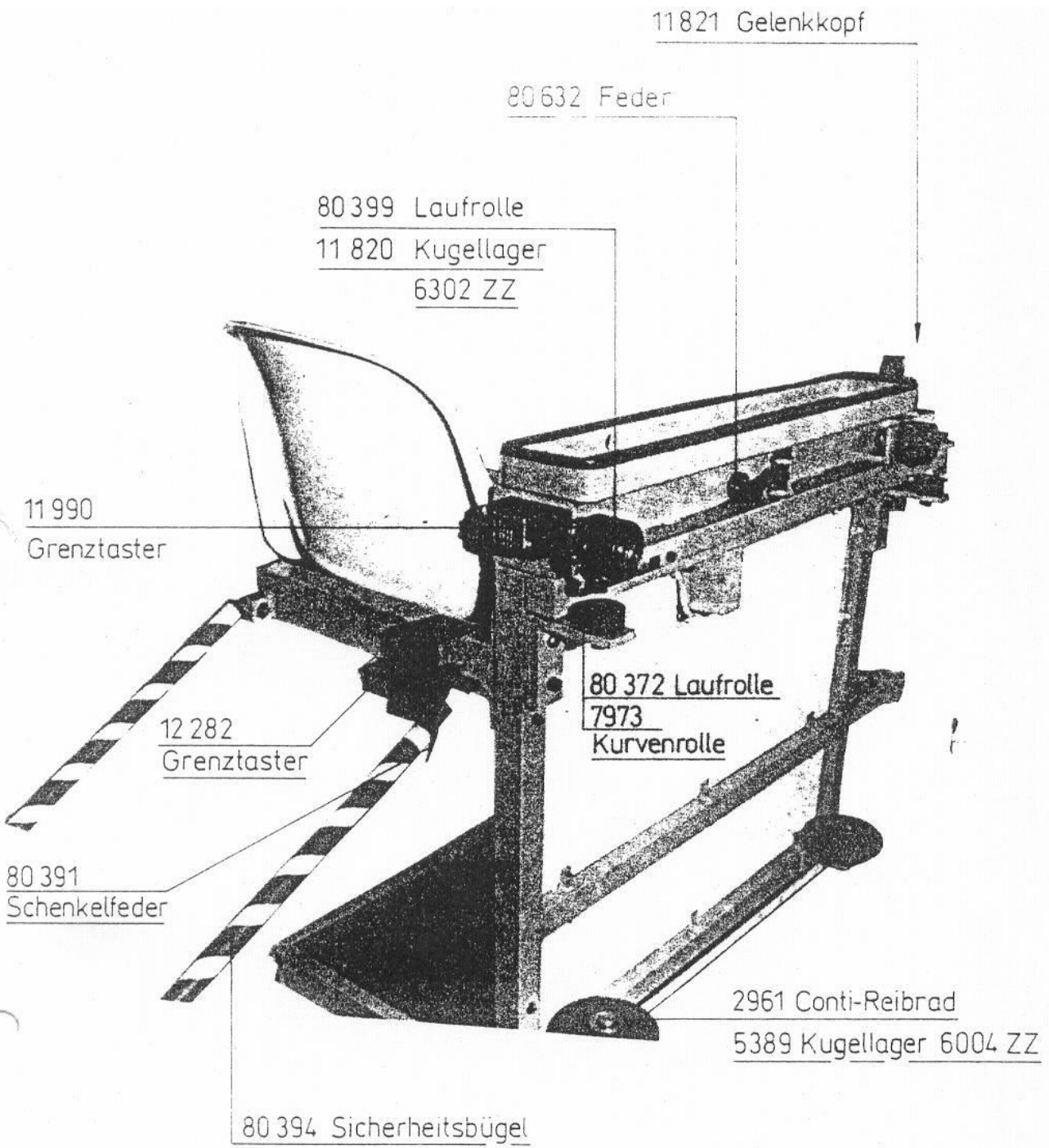

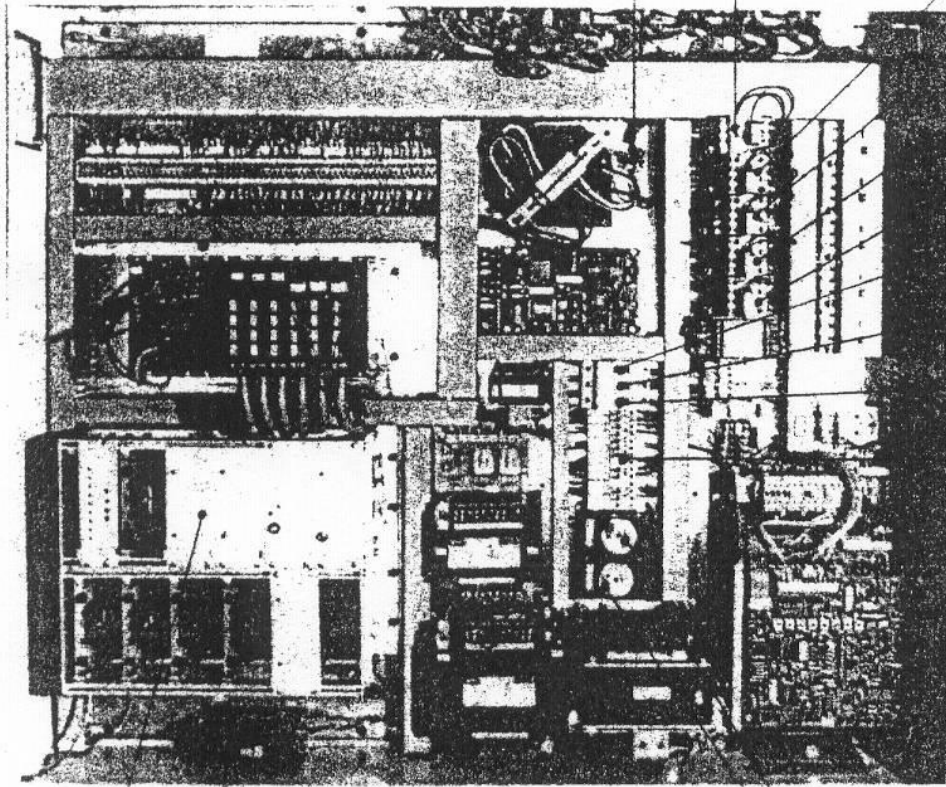

12 894

50 109 K 1

51 005 K 40
+12 256

51 006 K 41
+11 338

51 005 K 42
+11 396

51 005 K 3
+11 396

12 330 F 1

12 328 F 2

12 328 F 3

F4	M4A
F5	M4A
F6	M10A
F7	M6,3A
F8	frei
F9	M6,3A
F10	frei
F13	M6,3A
F14	M2A
F15	M2A
F16	M6,3A
F17	M2A
F18	M2A
F19	frei

12 395

11121 F11+F12

6927RC-Glieder unter Baugruppenträger montiert

Silized-Sicherung 35A

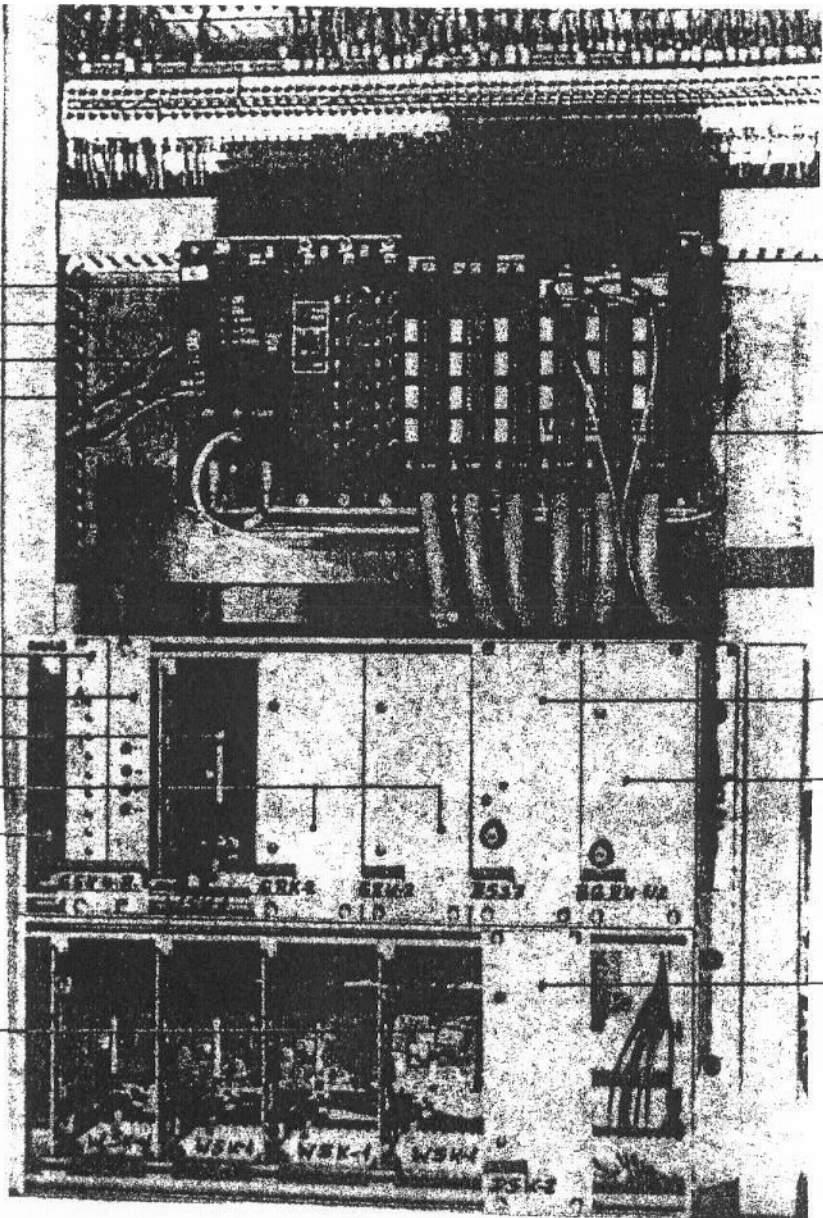

347
11 718
12 350
12 350

12 325

12 326

GSK-4B 11935
KRK-4 11086
WSK-1 11903
GRK-2 11904
KRK-1 11900

11901

11902

WSK-1 11903

11933 DSK-2

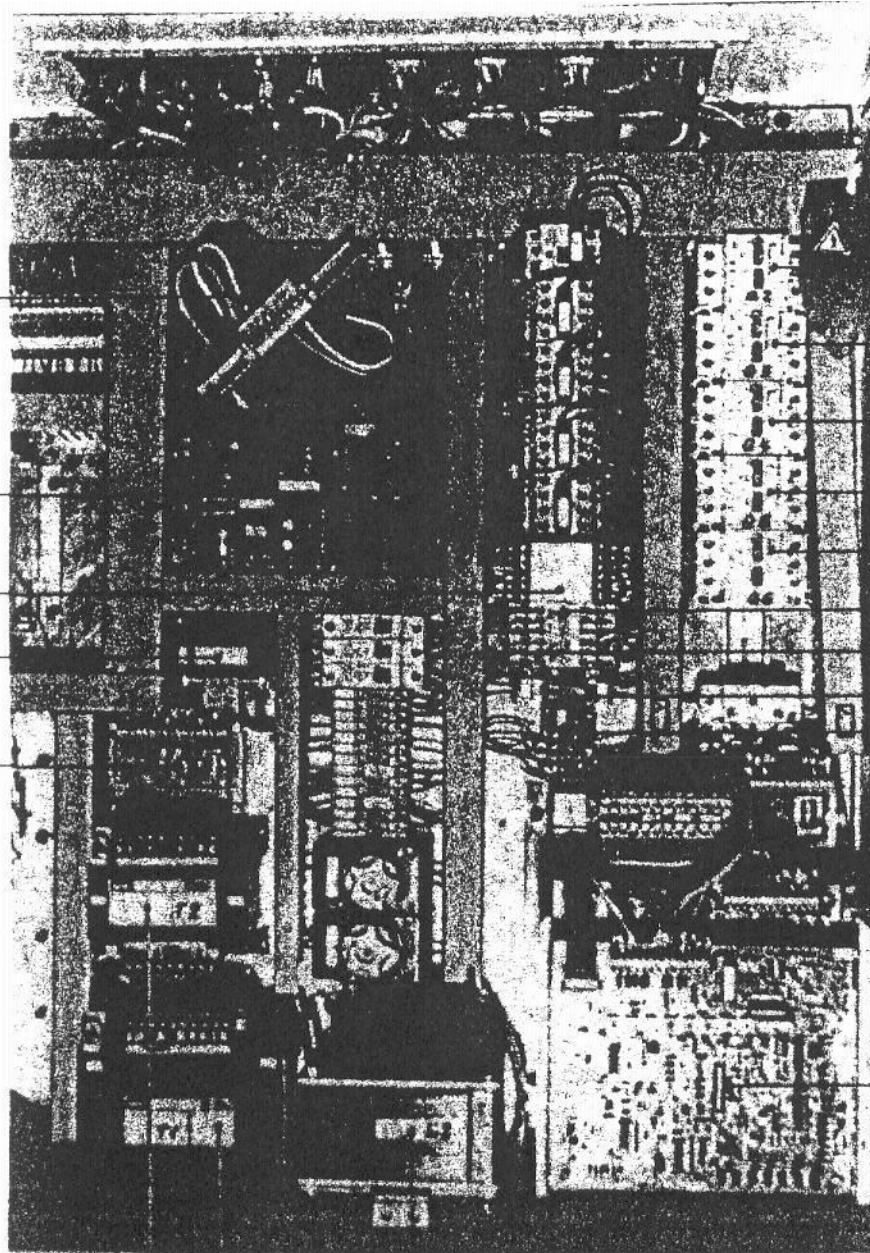

11788

12 968 - 12 969

50 599

11788

10 947 EASI

11 122

11 123

11 123

11 234

11 270

12 898 3 sec.

12 332 1 sec.

11 203

12 366

12 936

12 937

10 943 Trafo 320 VA

50 107 Trafo 800 VA

12 935 Gleichstrom-Aufsteck-Flachgetriebe-
Nebenschlußmotor

12 995 Flanschlager

80 059 Kettenrad

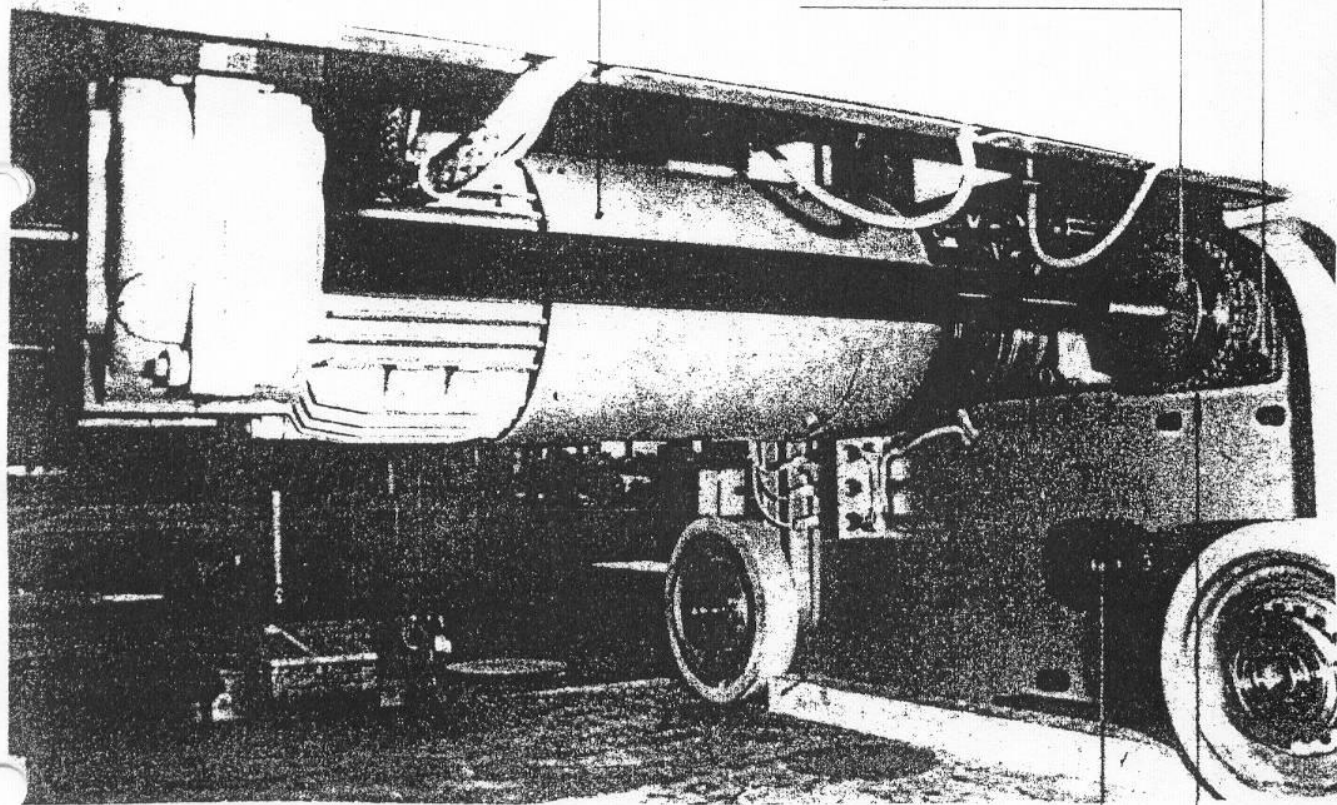

80 058 Kettenrad

5388 Kugellager

6384 Zweifachrollenkette

12 998 Kettenschloß